



MANUAL – INSTALLATION & SERVICE



Price Intelligent Controller

PIC-SD Series

v400 – Issue Date: 07/06/21

© 2020 Price Industries Limited. All rights reserved.



PRICE INTELLIGENT CONTROLLER

TABLE OF CONTENTS

Product Overview

General	1
Input/Output Description	1
Price - Flow Response Chart.....	2
Thermostat Overview	3

Installation

Thermostat Installation	5
Mounting Instructions.....	6
Wiring	7

Balancing

Balancing Instructions	8
------------------------------	---

Display Navigation

Initial Setup	10
Info Menu.....	11
Service Menu	12
Application Menu	13
Balancing Menu	14
VAV Menu	15
Setpoint Menu.....	16
Discharge Air Temperature Menu.....	18
Input Menu.....	19
Output Menu	21
BACnet Menu	26
Stat Setup Menu	27
Display Options Menu	28

BACnet Networking

BACnet Wiring	29
BACnet Networking And Setup	30
Setting The Device Instance	31
BACnet Service Menu	33

Maintenance

Troubleshooting.....	35
Hardware Specifications.....	38

SUPPORT ▼

Having difficulty installing this product?
Price is here to help.

Application Support

204.654.5613 option 4

controls@priceindustries.com

priceindustries.com/controls

PRICE INTELLIGENT CONTROLLER

PRODUCT OVERVIEW

General

PIC-SD - Price Intelligent Controller

The Price Intelligent Controller (PIC-SD) is a direct digital controller for VAV terminals and fan coils that offers cutting edge zone control. An advanced and configurable proportional integral controller allows for exceptional user comfort and energy efficiency. Installation of the controller and thermostat is simple and error proof with RJ-45 (network type) connections to the thermostat.

The PIC-SD typically comes factory mounted to Price VAV boxes, but may also be ordered by itself for retrofit jobs.

The PIC-SD can be used as a stand alone unit, or can be interfaced into a BAS with MS/TP BACnet capability using the onboard +/- and NET com network connection terminal block. The PIC-SD controller offers 5 thermostat options, 2 binary outputs, 2 analog outputs, and 2 analog inputs - all fully configurable from an LCD thermostat. The PIC-SD controller can control analog heating and cooling valves, fan motors, other types of analog devices, as well as on/off heating and cooling stages, on/off fan operation, fan coils, etc.

PIC-SD - PRICE INTELLIGENT CONTROLLER ▼

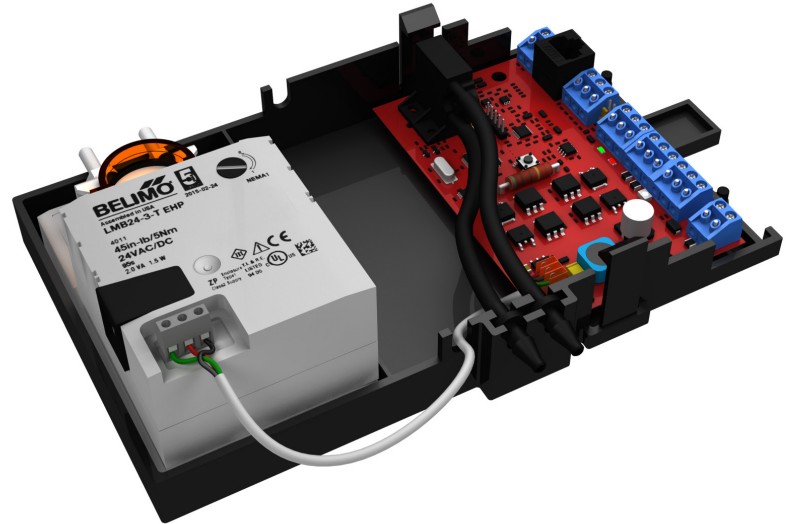

Input/Output Description

24VAC Binary Outputs	
BO1	configurable for heat, cool, fan, lights
BO2	configurable for heat, cool, fan, lights
AO1	configurable for heat, cool, ECM fan
AO2	configurable for heat, cool, ECM fan
SAT Sensor	Analog input for temperature probe hookup for heat/cool changeover if required. 10k type J thermistor
Contact Closure	Configurable binary input used for night setback, force damper open/close, halting all outputs etc.

Switched HOT/COM Jumper: PIC-SD offers a jumper selectable HOT/COM switch that allows the binary outputs to be switched HOT or switched COMMON.

COM Terminals: All COM terminals on the PIC-SD controller are internally connected, which allows for a common reference point throughout the board.

Damper Actuator: Factory installed and wired. Drive time of the actuator is 90 seconds.

T-Stat RJ-45 Port: The PIC-SD comes equipped with an RJ-45 port to provide easy thermostat cable installation from the PIC-SD to any of the selected thermostats.

PRICE INTELLIGENT CONTROLLER

PRODUCT OVERVIEW

Price - Flow Response Chart

HCCO box		Cooling Min	Cooling Flows	Heating Min	Heating Flows	Neutral Supply Air Flow
PI = Cooling	Duct Air = Cold		x			
PI = Heating	Duct Air = Cold			x		
PI = Neutral	Duct Air = Cold	x				
PI = Cooling	Duct Air = Hot	x				
PI = Heating	Duct Air = Hot				x	
PI = Neutral	Duct Air = Hot	x				
PI = Cooling	Duct Air = Neutral					x
PI = Heating	Duct Air = Neutral			x		
PI = Neutral	Duct Air = Neutral					x

NOTE 1: If no Temperature Probe is present, the PIC-SD controller assumes cold duct air.

NOTE 2: PI = Proportional Integral = room load (either cooling/neutral/heating)

Above is a Flow Response chart for the PIC-SD controller, showing the demand, Duct Air condition, and the controller's output.

Example: If PIC-SD is trying to heat the room (PI = heating) and cool air is being supplied (Duct air = Cold) it will target its heating min flow.



TECH TIP ▼

Use the above table to determine what airflows are being targeted in certain modes.

The heating/cooling change over temperature probe uses a dynamic heat/cool changeover algorithm.

PRICE INTELLIGENT CONTROLLER

PRODUCT OVERVIEW

Thermostat Overview

Room Sensor Thermostat

- The Room Sensor Thermostat is powered from the controller.
- Measures room temperature.
- Setpoint can be adjusted from a hidden dial on the back of the T-Stat.
- Setpoint limits can be adjusted through free setup software using the Price LCD-SETUP, or through a BACnet system.
- Eliminates problem of unauthorized tampering to the thermostat.
- Occupancy button can be used to override the system during unoccupied times. Default setting is 4 hours.

Dial Thermostat

- The Dial Thermostat is powered from the controller.
- Measures room temperature and features a dial adjustment and an occupancy button.
- Temperature Setpoint limits can be adjusted through free setup software using the Price LCD-SETUP, or through a BACnet system.
- Simply use the adjustable dial for temperature adjustment.
- Occupancy button can be used to override the system during unoccupied times. Default setting is 4 hours.

LCD Thermostat

- The LCD Thermostat is powered from the controller and has a variety of features.
- Measures room temperature and features an LCD screen with push button day Setpoint adjustment.
- Temperature Setpoint limits are set through the T-Stat setup menus, free setup software using the Price LCD-SETUP, or through a BACnet system.
- The LCD Thermostat can be used as a balancing tool for the controller system by connecting the RJ-45 cable to the back of the thermostat.

LCD Thermostat with Motion Sensor

- The LCD Thermostat with Motion Sensor is powered from the controller and has a variety of features as well.
- This model measures room temperature, features an LCD screen with day Setpoint adjustment, and motion sensor with lighting control.
- Temperature Setpoint limits are set through the T-Stat setup menus, free setup software using the Price LCD-SETUP, or through a BACnet system.
- Balancing and additional setup functions are also available through the menus.
- This thermostat can also be used as a motion sensor for occupied and unoccupied times in a space. It also has the capability to act as a lighting controller for occupied/unoccupied schedules.

ROOM SENSOR THERMOSTAT ▼



DIAL THERMOSTAT ▼



LCD THERMOSTAT ▼



LCD THERMOSTAT W/ MOTION SENSOR ▼



PRICE INTELLIGENT CONTROLLER

PRODUCT OVERVIEW

The Price Wireless Thermostat System provides both sensor inputs and a point of control for Price controllers.

The System consists of 2 units:

WIRELESS REMOTE T-STAT - Transmitter - Room sensor T-Stat with dial setpoint adjust, LED and push button.

WIRELESS BASE - Receiver - Unit with LCD and 3 push buttons.

REMOTE T-STAT and BASE units talk between each other wirelessly in the 2.4GHz range (FCC and IC certified). BASE unit connects to main controller using the supplied plenum-rated CAT-5 cable. No other connections are required.

WIRELESS THERMOSTAT ▼



Base (Receiver) Mounted in Plenum

- LCD Screen for menu display
- Increase and decrease push buttons for day temperature setpoint adjustment
- Menu Button

Remote (Transmitter) User Thermostat

- Dial Adjustment for Temperature
- LED – 1 blink cooling mode, 2 – heating, 3 – neutral
- Occupancy Override Button

LCD Thermostat with CO2 and Humidity

- The LCD Thermostat with CO2 and Humidity is powered from the controller and with an additional 24 VAC supply.
- This model measures room temperature, CO2, relative humidity, and features an LCD screen with day Setpoint adjustment.
- Available CO2/RH strategies are Tracking Mode and Purge Mode
- Temperature Setpoint limits are set through the T-Stat setup menus, free setup software using the Price LCD-SETUP, or through a BACnet system.
- Balancing and additional setup functions are also available through the menus.

CO2/RH LCD THERMOSTAT ▼



PRICE INTELLIGENT CONTROLLER

INSTALLATION

Thermostat Installation

General Description

The PIC-SD thermostats are all physically the same size and mounting instructions will be typical.

Location

1. The Price Intelligent Controller (PIC-SD) Thermostats must be mounted to a wall and wired to the controller via the supplied plenum rated 35ft CAT-5 cable. This cable plugs into the thermostat and the PIC-SD controller with the ease of RJ-45 connections. **NOTE:** the cable run can be extended to 70 ft using a Price Cable coupler and additional 35ft cable.
2. Mount the required thermostat in a place that is convenient for the end user, but the following should be taken into consideration:
 - Do not mount a thermostat in direct sunlight i.e. across from a window where heat can alter the temperature reading.
 - Should not be installed on an outside wall.
 - Keep away from hot equipment like computers, monitors and heaters etc.
 - Ensure nothing will restrict vertical air circulation to the thermostat. (Do Not Cover)
 - Ensure wall is NOT pressurized! Hot/Cold air from a pressurized wall will direct blow onto the thermostat's temperature sensor causing 'bad' readings.

Installation

1. The back plate on each thermostat is removable and can be mounted to a standard electrical box or directly to drywall using anchors supplied by others.
2. Run the CAT-5 cable through the center hole in the plate. Connect the cable to the thermostat, then secure the thermostat onto the wall plate inserting top portion of the thermostat first, then snapping the bottom half in.
3. All thermostats will come equipped with a 0.050" Allen Key for the set screw at the bottom.

SURFACE MOUNT DETAIL ▼

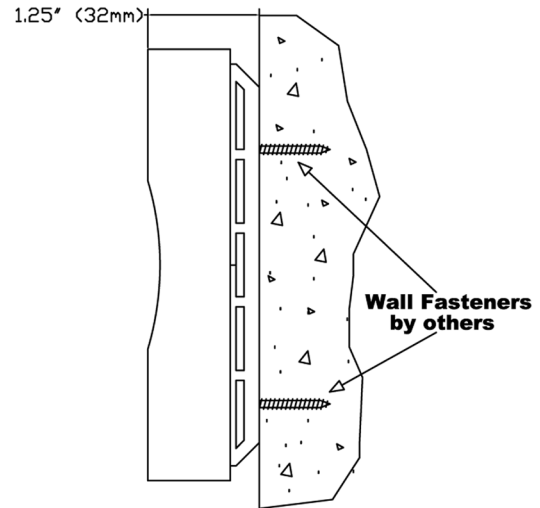

35 FOOT PIC-CABLE ▼

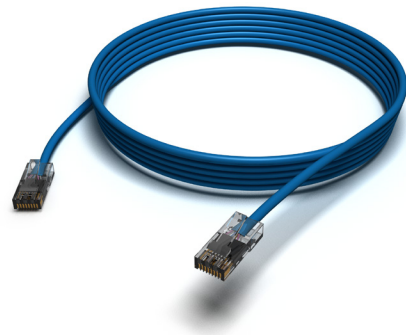

TECH TIP ▼

Careful thermostat installation will reduce field issues! Do not twist or kink the blue CAT-5 thermostat cable. Damaged cables are difficult to troubleshoot!

A thermostat whose cable has been kinked will display the message 'Waiting for Link Check Wiring'

Thermostat cable product code: NETC35

PRICE INTELLIGENT CONTROLLER

INSTALLATION

Support: Having difficulty installing or configuring this product? Price is here to help.

Controls Application Support: 204.654.5613 | controls@priceindustries.com | priceindustries.com/controls

Mounting Instructions

Mount the PIC-SD by sliding the actuator U-Bolt over the damper shaft. The back end of the PIC-SD is secured by installing the provided sheet metal screw (taped to the controller). This keeps the PIC-SD from moving when the actuator is turning, but still allows it to “float” to avoid binding on the shaft if the controller were screwed firmly in place.

Rotate the damper shaft all the way in one direction (either clockwise or counter-clockwise) and then depress the clutch on the actuator to unlock the actuator, and rotate it all the way in the same direction the shaft was rotated in.

Tighten the nuts on the U-bolt clamp and secure the actuator to the damper shaft.

Depress the clutch again and verify the actuator and shaft can rotate through the full 90° range of motion.

NOTE: It does not matter if you choose clockwise or counter-clockwise to rotate the shaft and actuator before tightening the nuts. The PIC will calibrate on power up. All that matters is that the damper shaft and actuator have the full 90° range of motion.

Connect any of the controller's outputs as required.

NOTE: When the output loads require a switched HOT or COMMON 24VAC signal. Use the jumper near the analog outputs to select HOT or COMMON outputs.

Power the PIC-SD using 24VAC, the secondary 24VAC Power the PIC using 24VAC, the secondary 24VAC common of the transformer must be earth grounded, or powered with Price PPM power module by plugging the supplied cables into the RJ-12 power jacks.

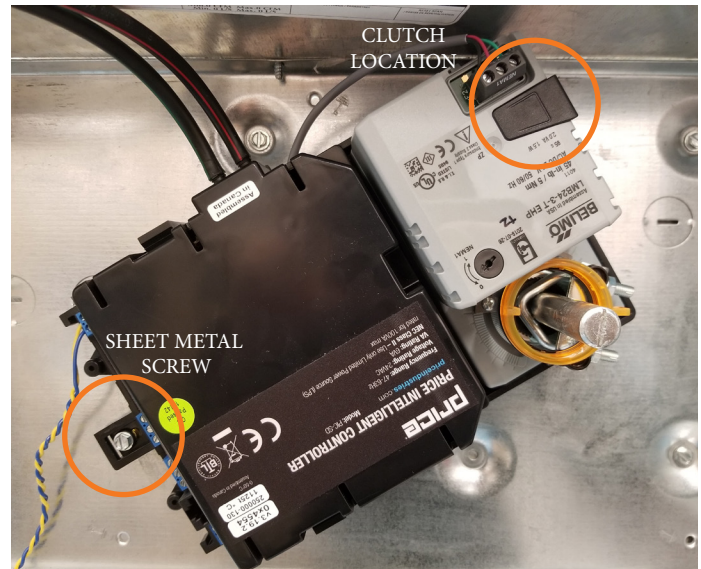

PRICE INTELLIGENT CONTROLLER

INSTALLATION

Wiring

Below is an example of a typical PIC-SD sequence diagram - Single duct box with 2 stages of binary heat. Each PIC-SD comes factory programmed with a specific sequence, but adjustments can be made in the field using an LCD thermostat.

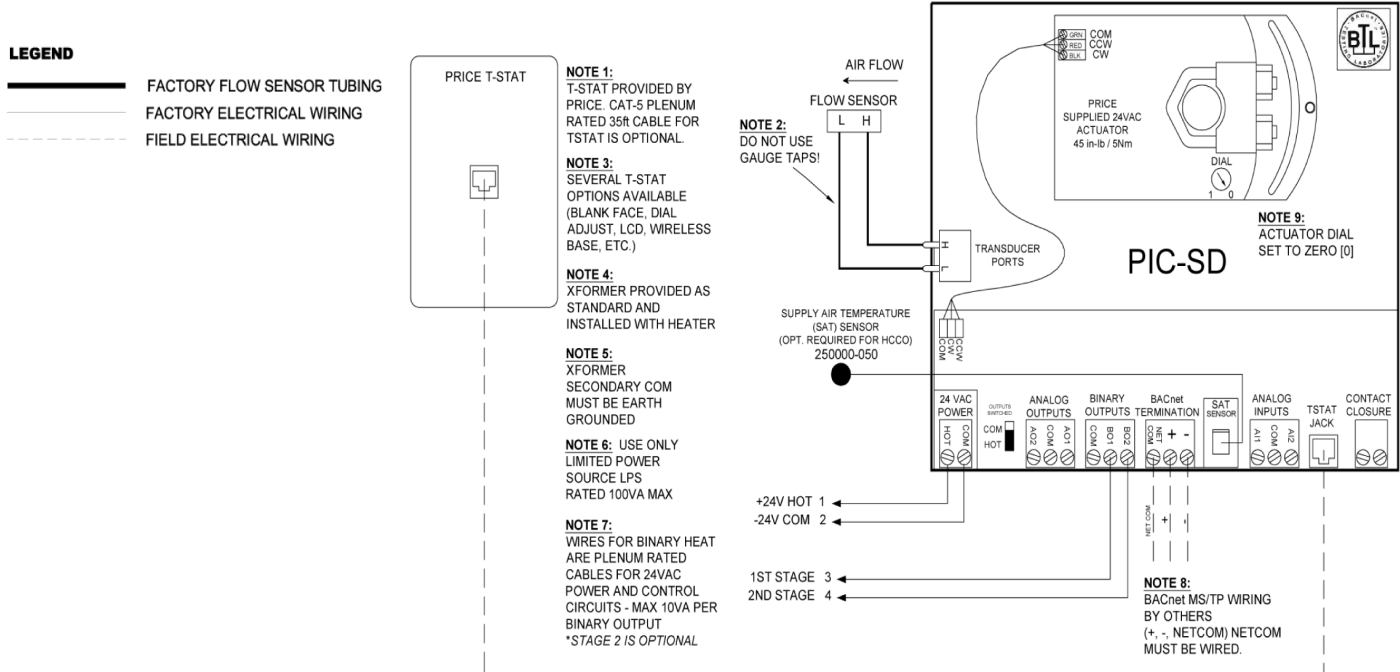

NOTE: Suitable heating flow must be selected in order to maintain flow through energized electric coils of at least 200fpm and at least 70cfm/kW throughout the entire operating range. The PIC generally targets the HEAT MIN FLOW while reheat coils are operating.

Sequence of Operation - Heat/Cool changeover OR cooling with up to 2 stage binary reheat - Pressure Independent. On power up the damper will calibrate closed for 2 minutes. **If no SAT sensor is present, the controller assumes Cool supply air at all times.**

Cool Supply Air: On an increase in space temperature, the controller regulates the actuator to open the VAV damper and increase the flow of cool air. On an increase of space temperature greater than the cooling proportional band, the airflow is maintained and its pre-selected maximum setting.

On a decrease in space temperature the controller regulates the actuator to close the VAV damper and reduce the flow of cool air. If the space temperature decreases to less than the cooling proportional band, the airflow is maintained at the pre-selected minimum setting.

Warm Supply: On a decrease in space temperature, the controller regulates the actuator to open the VAV damper and increase the flow of warm air. On a decrease of space temperature greater than the heating proportional band, the

airflow is maintained at the pre-selected maximum setting.

On an increase in space temperature, the controller regulates the actuator to close the VAV damper and reduce the flow of warm air. If the space temperature increases above the heating proportional band, the airflow is maintained at the pre-selected minimum setting.

Reheat Operation: On a decrease in space temperature into the heating proportional band, the first stage binary 24VAC reheat output will energize. Upon further decreases, the second stage of reheat will energize.

CONTROL GRAPH ▼

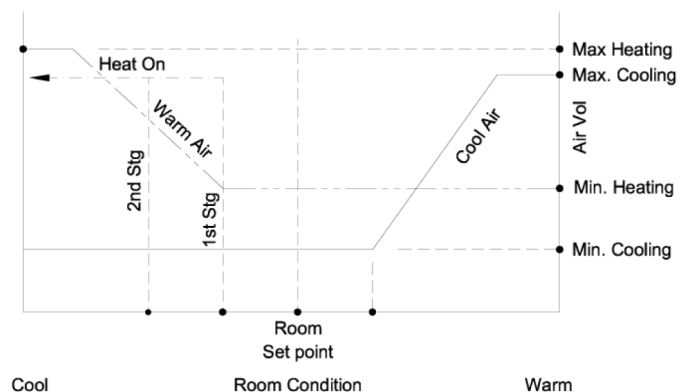

PRICE INTELLIGENT CONTROLLER

BALANCING

Support: Having difficulty installing or configuring this product? Price is here to help.

Controls Application Support: 204.654.5613 | controls@priceindustries.com | priceindustries.com/controls

Balancing Instructions

For more advanced setup details, please see 'Display Navigation' section.

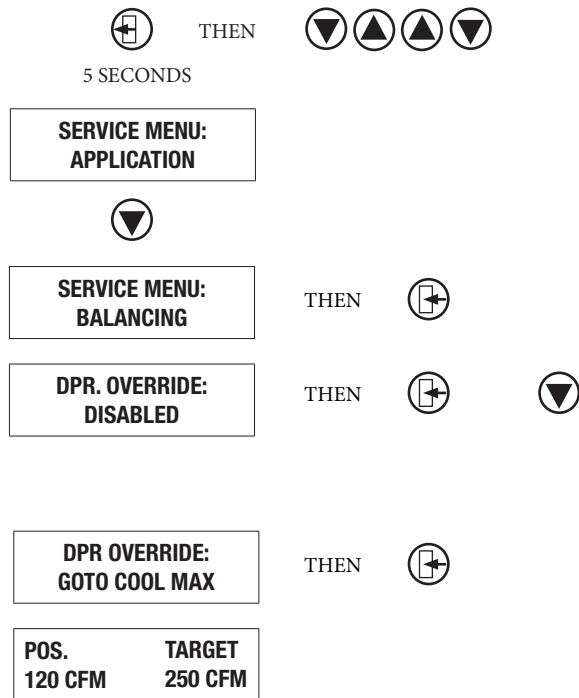

Hold down the **Menu** button on the LCD Thermostat for **5 seconds** until prompted for a passcode; use ▲ and ▼ to enter the passcode; **DOWN, UP, UP, DOWN**.

The screen will now display "Service Menu: Application."

Scroll down to the Balancing sub-menu.

Press the **Menu** button to enter this menu.

Screen will now show "Damper Override Disabled." Press **Menu**, and now "Disabled" will begin flashing; this means you can now scroll **UP** or **DOWN** with the arrow keys to select a target to send the damper to.

For most applications, you will want to select "Go To Cool Max," and once selected, the thermostat will read the actual CFM (position) and target CFM as the damper tries to lock on to the cooling max airflow.

NOTE: If the target is zero, airflows must be entered in the VAV sub-menu - refer to page 18 of this manual.

Another option to override the damper is the "Flow Override" function. This will cause the damper to target any specific airflow that may not be cooling or heating min/max flow.

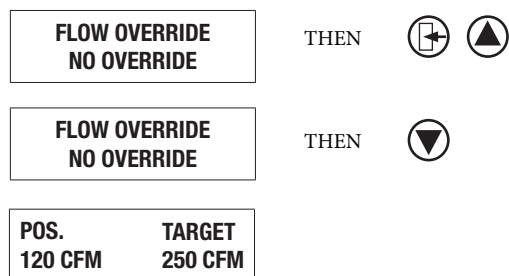

When the screen is displaying "Flow Override," press the **Menu** button and "No Override" will begin flashing. Press the **UP** arrow key to select a CFM value for the damper to target. Press **Menu** to select the value and press the **DOWN** arrow key to view the damper position vs target screen. The position should increase steadily until the target is reached.

NOTE: "Flow Override" must be set back down to "No Override" once complete.

Once the thermostat says that the position and target are the same, an airflow reading can now be taken from the air outlets. Compare your instrument's reading to what the thermostat is reading for an airflow. Some adjustment may be required. Adjustments are made in the 'Airflow Factor' menu, or, depending on the version of the controller, the 'Airflow Tweak' menu.

PRICE INTELLIGENT CONTROLLER

BALANCING

For Controllers with Airflow Factor Menu

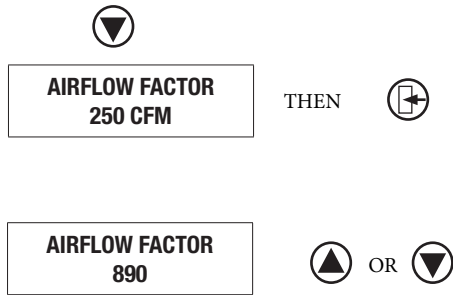

If any adjustment is required, press the 'DOWN' arrow key, the thermostat will now read 'AIRFLOW FACTOR' and will display its current CFM reading. Press the menu button and the CFM reading will change to display the current K factor, and the value will be flashing, indicating it is ready to be changed using the arrow keys.

Adjust the K factor by the percentage high or low that the balancing hood is reading versus the thermostat. For example, if the thermostat reads 250 CFM, but the balancer's hood reads 300 CFM, then divide 250 by 300 to get 0.833, this means the controller is reading 83.3% of what the balancer's hood is reading, so the K factor must be adjusted up. Supposing the box is an 8" inlet size, the K factor would be 890, so you would divide 890 by .833, and the new corrected K factor would be 1068.

$$K \text{ adjust} = K \text{ original} / (\text{CFM stat} / \text{CFM hood})$$

For Controllers with Airflow Tweak Menu

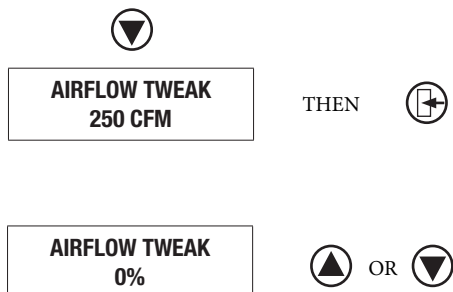

To make adjustments on controllers with airflow tweak instead of factor, scroll to the airflow tweak menu. The screen will display the current CFM. Press the menu button and the CFM reading will change to a flashing '0%'.

Adjust the % by the percentage high or low that the balancing hood is reading versus the thermostat. For example, if the thermostat reads 250 CFM, but the balancer's hood reads 300 CFM, follow the formula below to calculate the % higher or lower to offset the tweak.

$$\text{Tweak} = (1 / (\text{CFM stat} / \text{CFM hood}) - 1) * 100$$

Now, the thermostat's displayed CFM should much more closely match the hood's CFM reading.

Tech Support - CALL 204 654-5613 option 4
controls@priceindustries.com

PRICE INTELLIGENT CONTROLLER

DISPLAY NAVIGATION

Initial Startup

(LCD & Motion Thermostat only)

When the LCD thermostat is powered from the PIC-SD, it will display the following information:

PRICE ELECTRONICS	Start-up screen
LCD THERMOSTAT STANDARD MODEL	Standard/Motion Model
LCD THERMOSTAT VERSION X.XX	Displays firmware version of thermostat
LOADING: INITIALIZING	Loading parameters
DUCT SIZE 8 INCHES	Displays inlet duct size
PIC-SD VERSION X.XX	Controller type and controller firmware version
SEQUENCE XXXX	Displays sequence programmed into stat NOTE: a sequence number of 0 means the stat has NOT been calibrated
MAC ADDRESS XXX	Displays current MAC Address
DEVICE INST. XXXXXXXX	Displays current Device Instance
ROOM TEMP. 75.0°F	(For example)



Changing the Setpoint – LCD & Motion Thermostat only

Day Setpoint Adjustment

Increase and decrease push buttons for Day Setpoint adjustment



DAY SETPOINT
75.0°F

DAY SETPOINT
SAVING...

PRICE INTELLIGENT CONTROLLER

DISPLAY NAVIGATION

Info Menu

(LCD & Motion Thermostat only)

The Info menu shows information about the controller status regarding room load, damper position and BACnet Address info. No values can be changed from this menu and it is not locked or protected in any way.

Press 'Enter Menu' button to enter the User Menu, scroll through using the **up** and **down** buttons.

APPLICATION AIR TERMINAL	Single duct, fan powered terminal unit or fan coil
OCCUPANCY ON VVT MODE	The Occupancy can be determined by airflow, contact closure, motion or by a user pressing a button
NEUTRAL MODE LOAD 0%	Neutral mode mean PI controller is satisfied Cooling -1 to -100% Heating +1 to +100%
SUPPLY AIR TEMP 85.0°F	If no supply probe is present, LCD will display no probe If supply probe present, LCD will display temperature
DAMPER POSITION 50%	This indicates the current position of the damper is percent (%) Range is 0-100% (100% = full open or maximum air)
ECM OUTPUT 1.5 DVC	Current output voltage on AO assigned to ECM
AIRFLOW 300 CFM	Only displayed if system is pressure independent (PIC-SD-VAV module attached)
FLOW TARGET 300 CFM	Shows the current flow target in CFM (VAV) or % (VVT) NOTE: if damper position (above) is at 100% and CFM target is not being met, the box is STARVING for AIR
CO2 READING	The current CO2 reading in PPM (Parts Per Million)
HUMIDITY READING	The current humidity reading in RH% (relative humidity)
MAC ADDRESS 1	Shows the BACnet MAC address. Range 1-99 MAC Address can be set via dip watch If no BACnet module attached, LCD will display MAC address None
DEVICE INSTANCE 101	(Instance must be "globally" unique on your site) Displays controller's BACnet Device Instance (if BACnet is attached) Device Instance can range from 0-4, 194, 303
PRESS MENU TO EXIT	NOTE: Service menu will automatically time out after 20 seconds

PRICE INTELLIGENT CONTROLLER

DISPLAY NAVIGATION

Service Menu

(LCD Setup Only)

Hold down 'Enter/Menu' button for 5 seconds, display will show 'Passcode:'. Use Up and Down keys to enter the password in this sequence: **Down, Up, Up, Down**.

SERVICE MENU: APPLICATION	Change the Application the unit is operating as
SERVICE MENU: BALANCING	Allows you to force the damper open/close/min/max
SERVICE MENU: VAV/VVT	Allows you to set flows or set limits For VAV (Air Terminal application only)- page 15
SERVICE MENU: SETPOINT	Setup of Setpoint limits (day minimum/maximum). °F/°C selection
SERVICE MENU: INPUT	Shows supply air temperature reading. Shows if VAV and BACnet modules are attached.
SERVICE MENU: OUTPUT	Allows setup of FAN, HEAT, COOL, outputs. Allows setup of room light output (motion stat only).
SERVICE MENU: BACNET	Allows setup of BACnet addresses MAC address, Device Instance Baud Rate
SERVICE MENU: STAT SETUP	Allows setup of LCD back lighting, sounds, motion sensor. Adjustment of HVAC and room lighting time-outs.
DIAGNOSTIC	Restores default settings and resets controller
PRESS MENU TO EXIT	NOTE: Service menu will automatically time out after 20 seconds

PRICE INTELLIGENT CONTROLLER

DISPLAY NAVIGATION

Application Menu

Scroll through menu with 'Up' and 'Down' keys. Press Enter/Menu' button to apply your changes.
---Saving--- will display as your changes are applied.

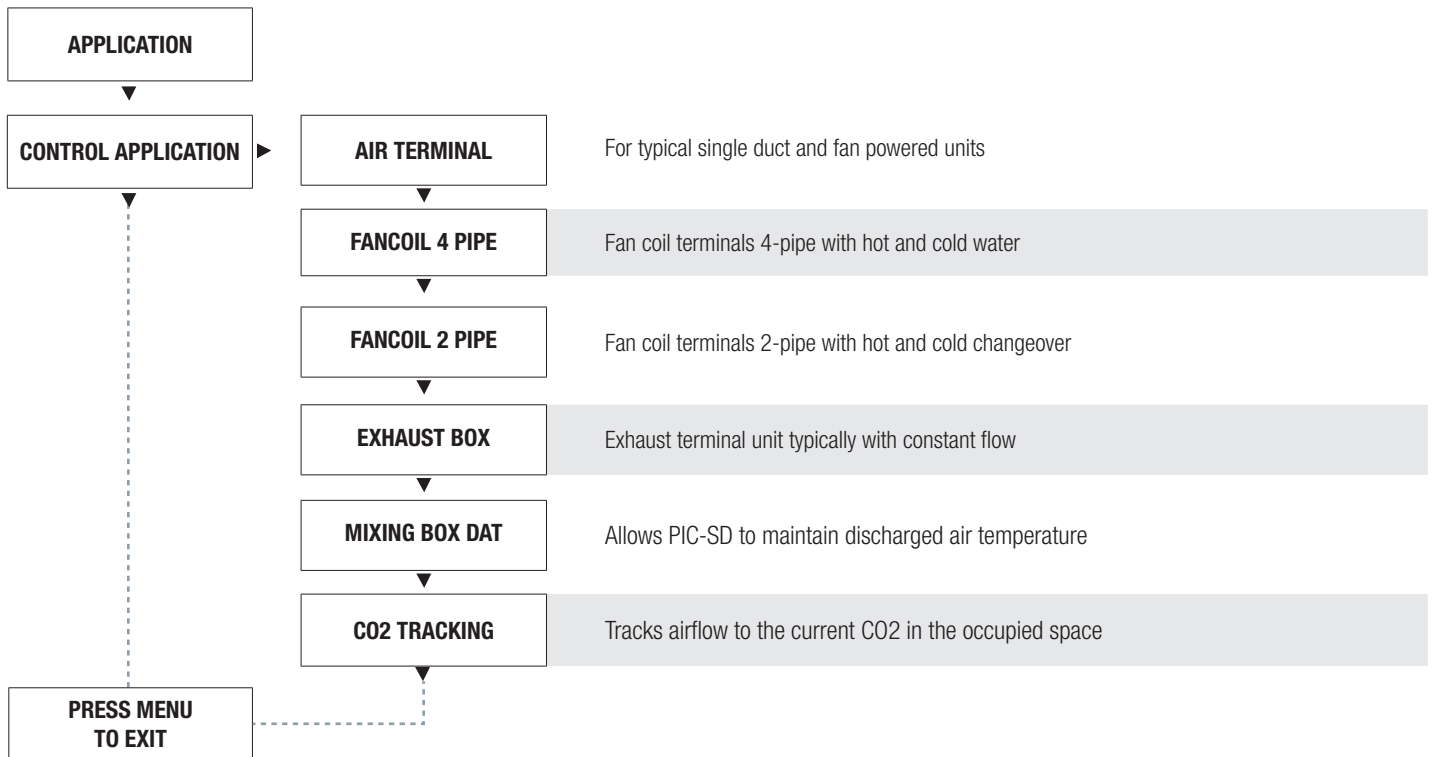

TECH TIP ▼

Depending on which application is selected, determines whether some menus will appear. Each menu item that is affected specifically states when it is visible.

PRICE INTELLIGENT CONTROLLER

DISPLAY NAVIGATION

Balancing Menu

Scroll through menu with 'Up' and 'Down' keys. Press Enter/Menu' button to apply your changes.

---Saving--- will display as your changes are applied.

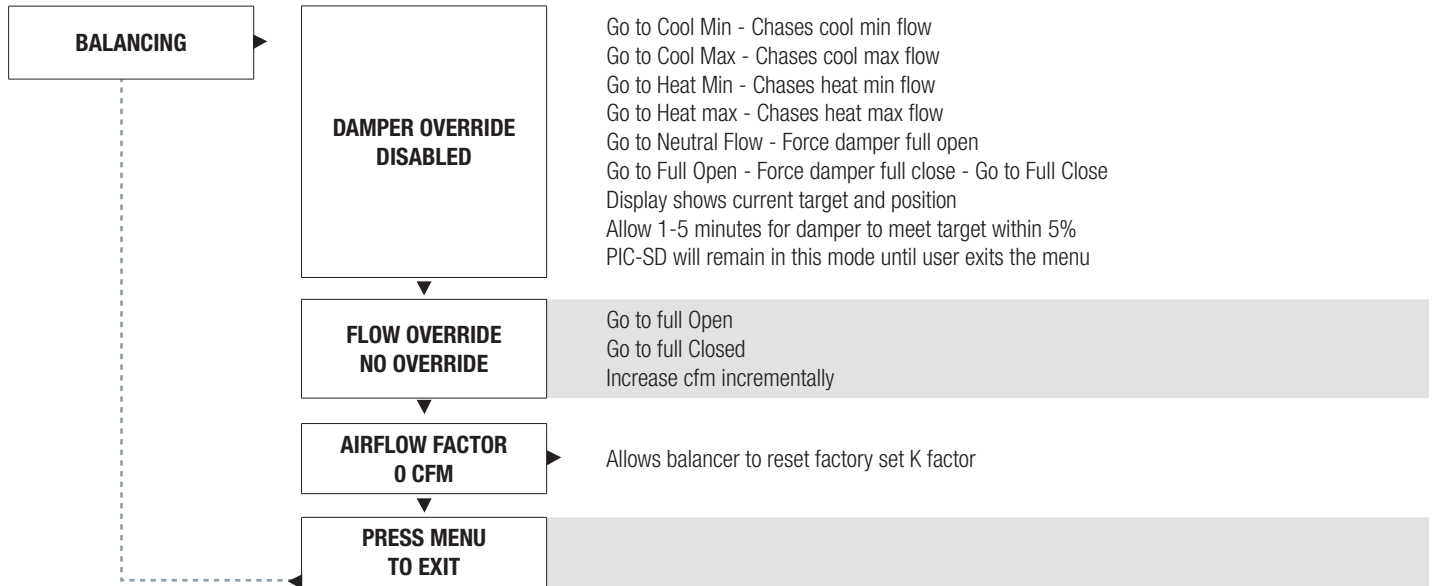

PRICE INTELLIGENT CONTROLLER

DISPLAY NAVIGATION

VAV Menu

(Pressure Independent Mode)

Scroll through menu with Up and Down keys. Press 'Enter/Menu' button to apply your changes. *---Saving---* will display as your changes are applied.

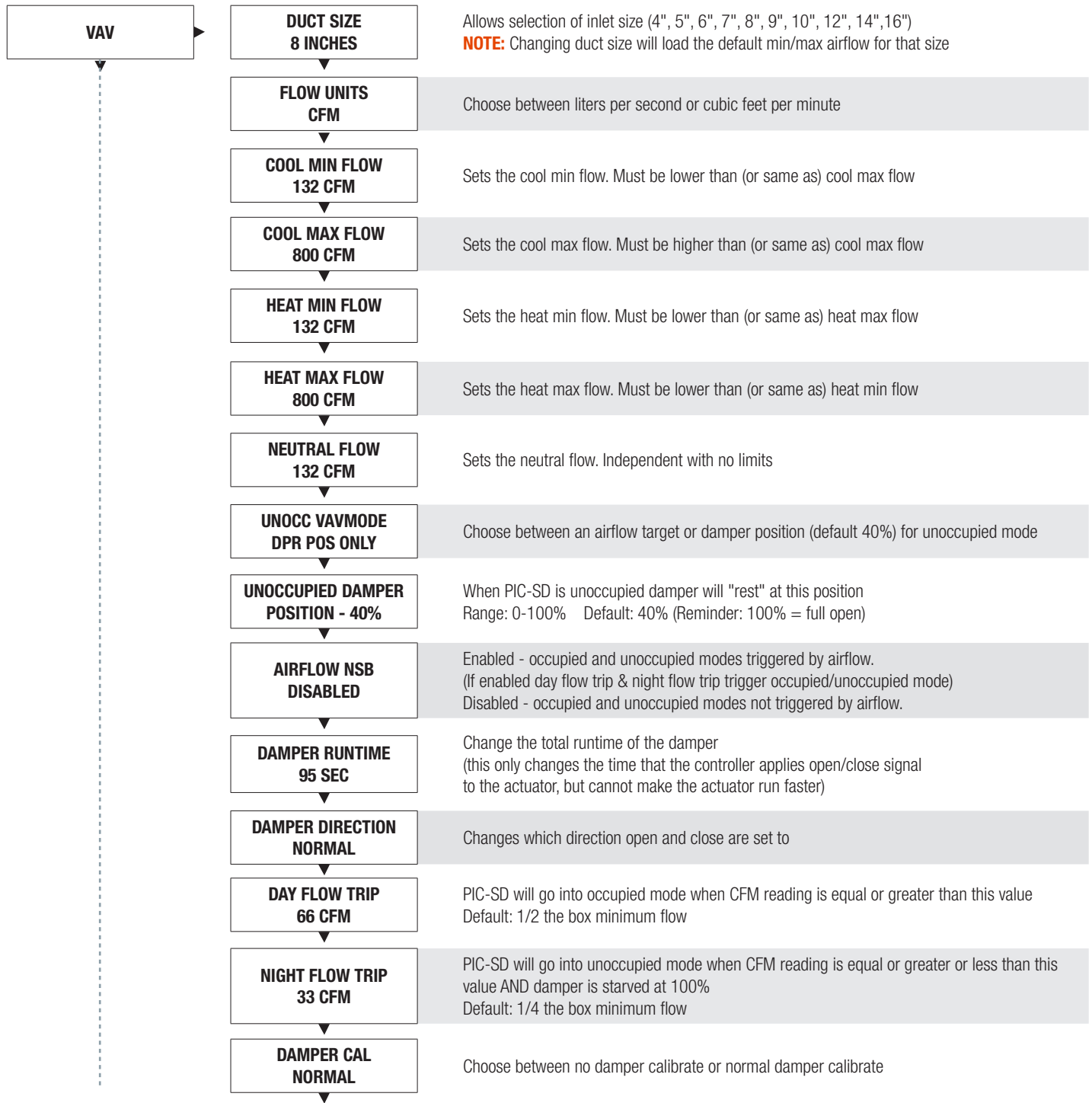

Continue to next page...

PRICE INTELLIGENT CONTROLLER

DISPLAY NAVIGATION

VAV Menu

(Pressure Independent Mode)

Scroll through menu with Up and Down keys. Press 'Enter/Menu' button to apply your changes. *---Saving---* will display as your changes are applied.

Continued from previous page...

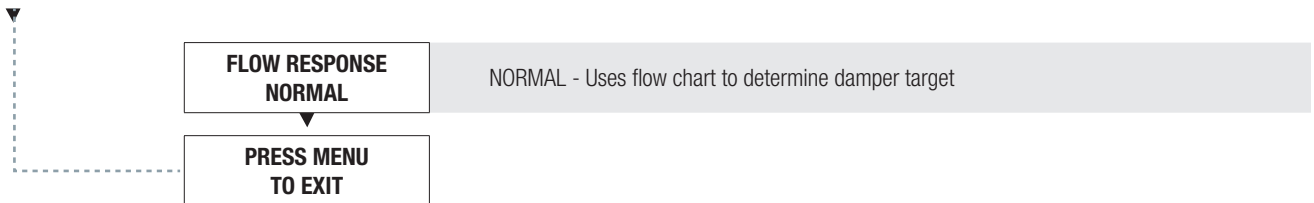

Setpoint Menu

(Setpoint Limits and Temperature Units)

Scroll through menu with Up and Down keys. Press 'Enter/Menu' button to apply your changes. *---Saving---* will display as your changes are applied.

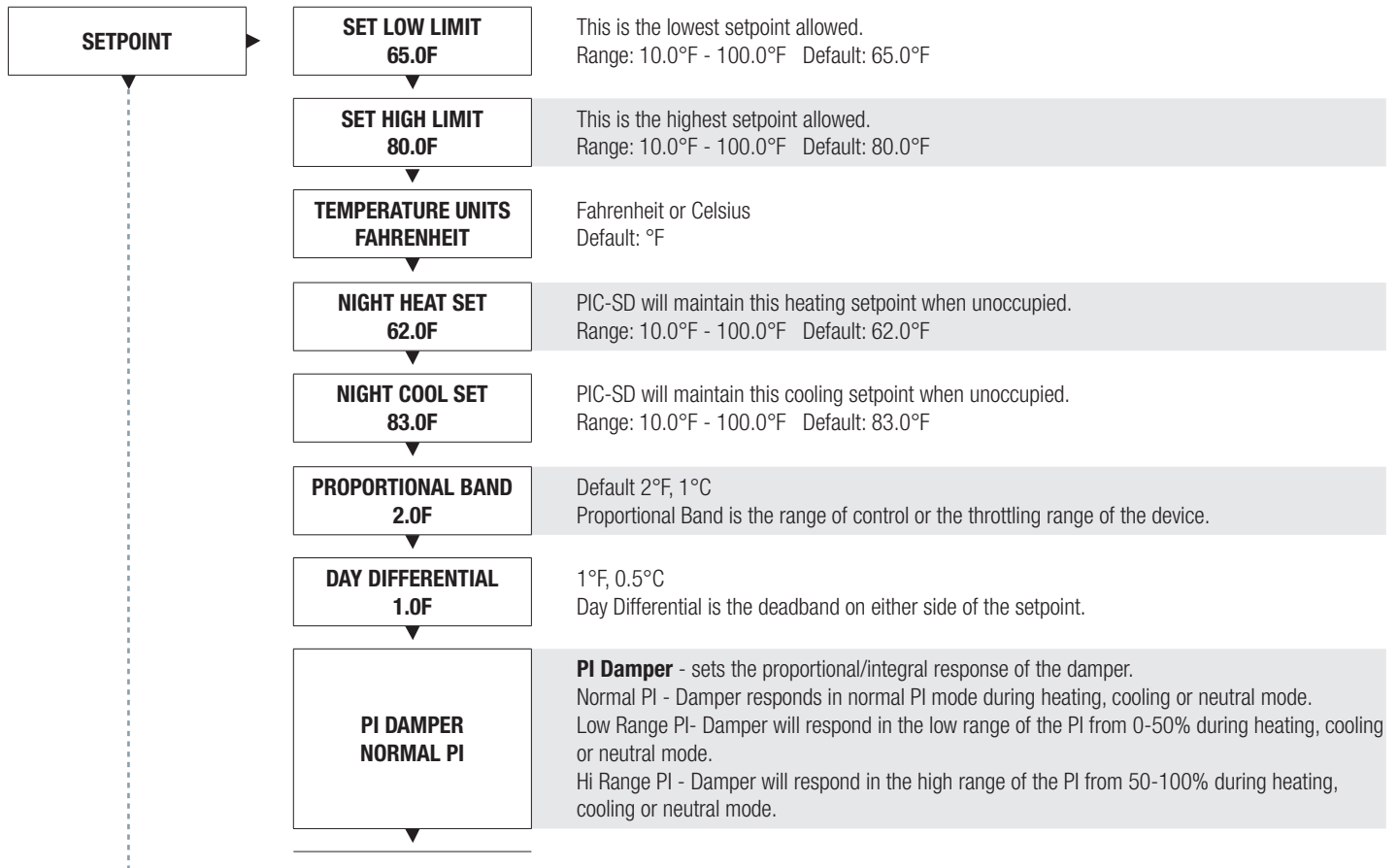

Continue to next page...

PRICE INTELLIGENT CONTROLLER

DISPLAY NAVIGATION

Setpoint Menu Continued

(Setpoint Limits and Temperature Units)

Scroll through menu with Up and Down keys. Press 'Enter/Menu' button to apply your changes. *---Saving---* will display as your changes are applied.

Continued from previous page...

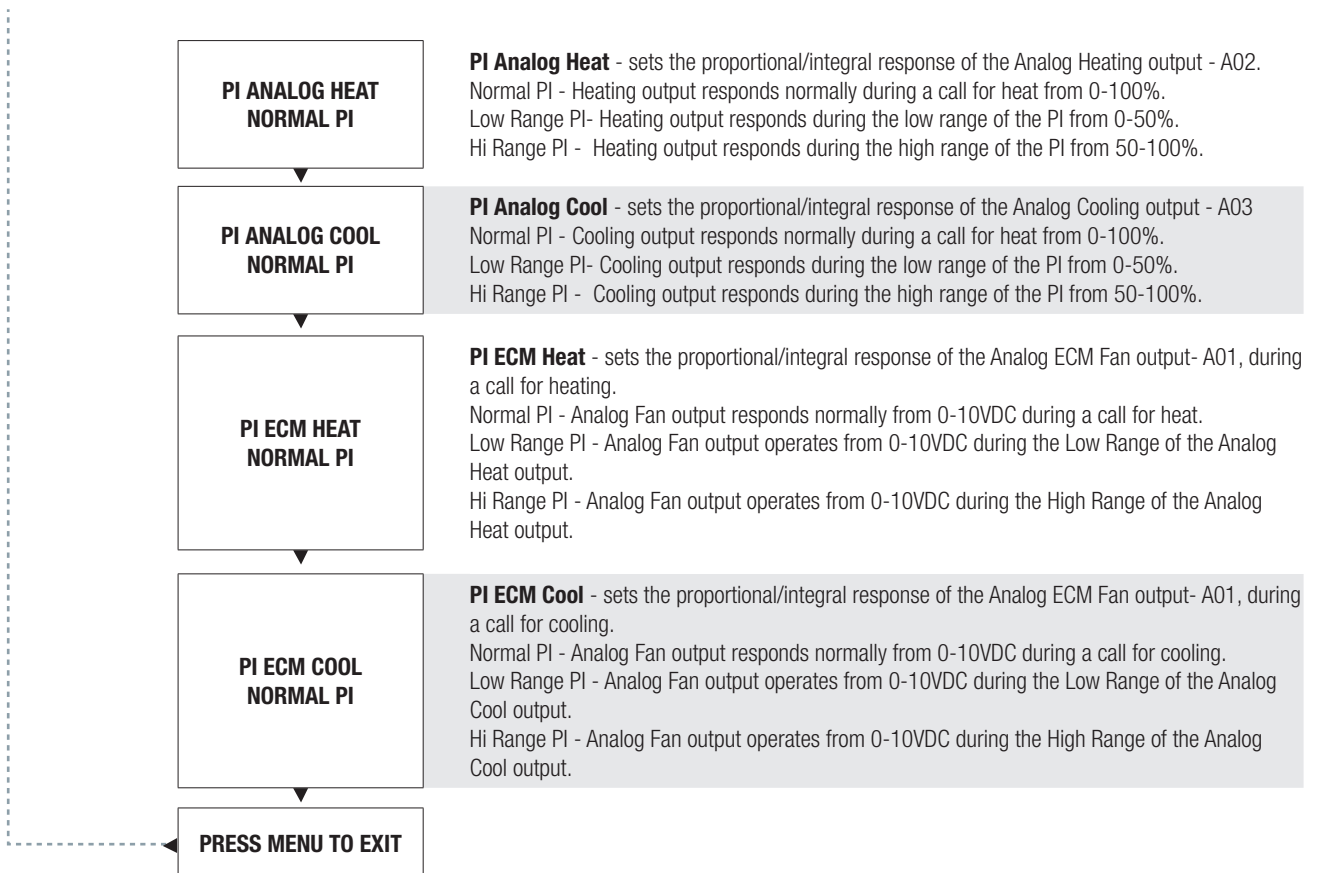

PRICE INTELLIGENT CONTROLLER

DISPLAY NAVIGATION

Discharge Air Temperature Menu

(Application specific options)

NOTE: Menu only present if 'Analog DAT Control' turned on in output menu

Scroll through menu with Up and Down keys. Press 'Enter/Menu' button to apply your changes. *---Saving---* will display as your changes are applied.

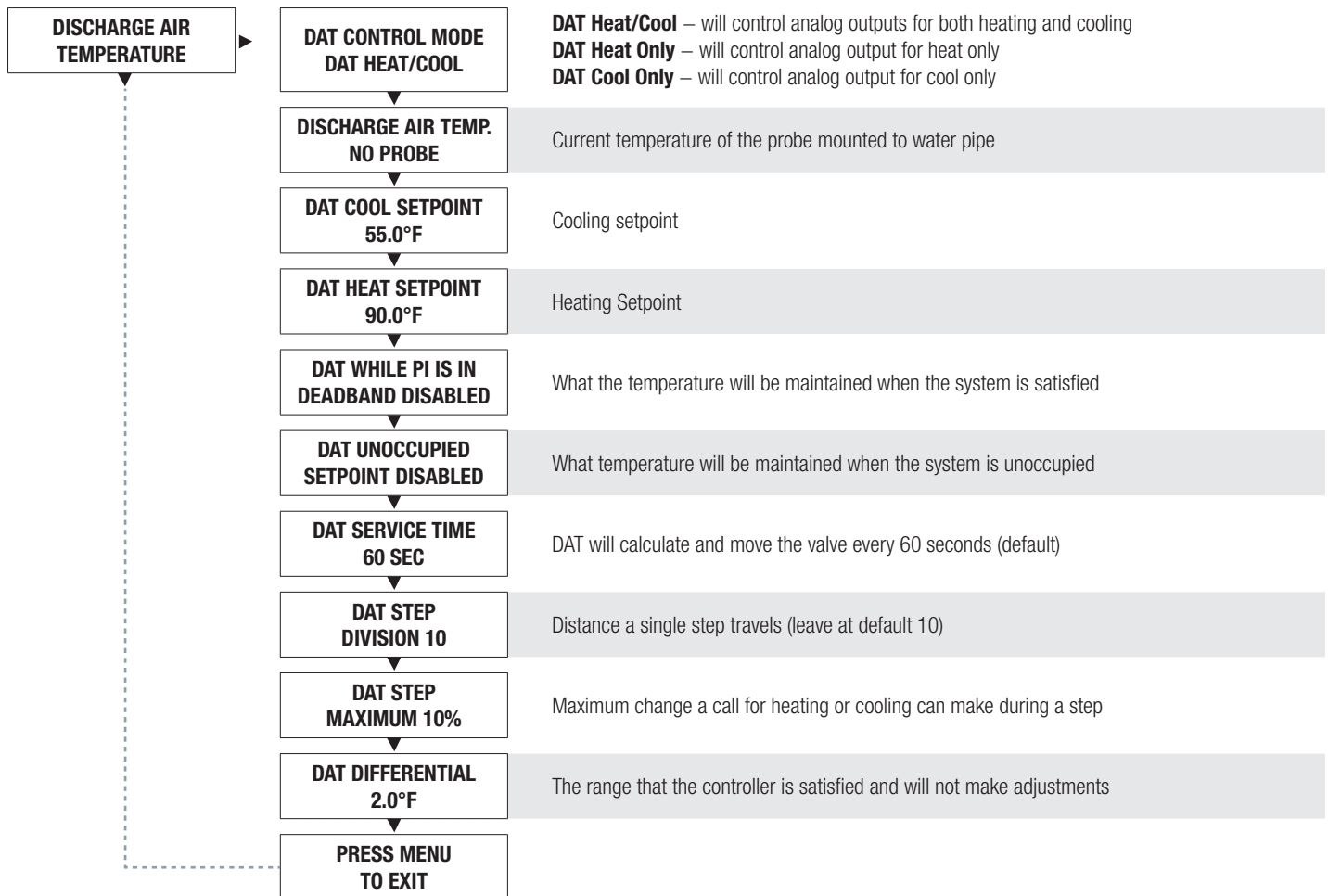

PRICE INTELLIGENT CONTROLLER

DISPLAY NAVIGATION

Input Menu

(Supply Air Temperature and Neutral Mode)

Scroll through menu with Up and Down keys. Press 'Enter/Menu' button to apply your changes. *---Saving---* will display as your changes are applied.

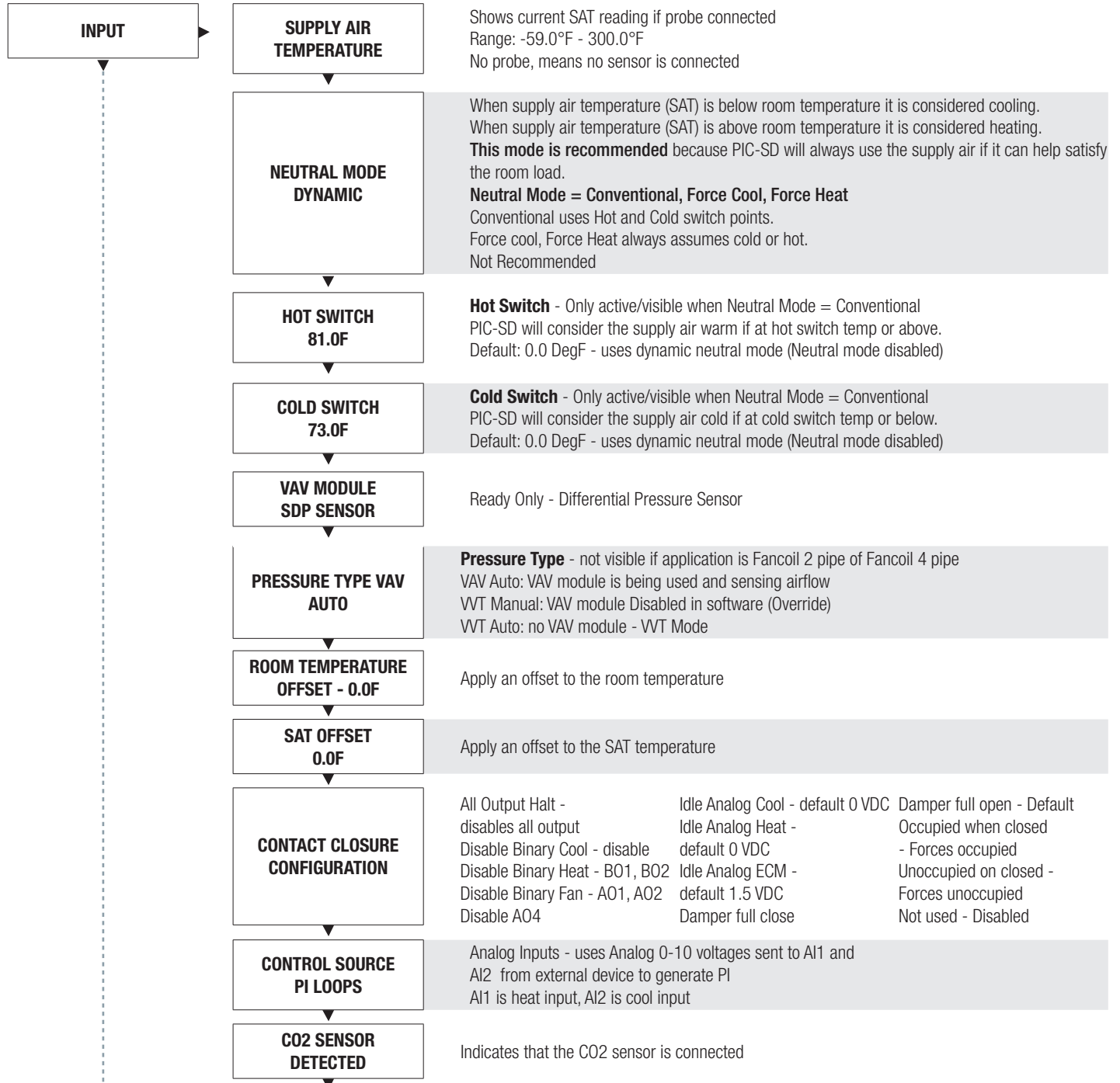

Continue to next page...

PRICE INTELLIGENT CONTROLLER

DISPLAY NAVIGATION

Input Menu Continued

(Supply Air Temperature and Neutral Mode)

Scroll through menu with Up and Down keys. Press 'Enter/Menu' button to apply your changes. *---Saving---* will display as your changes are applied.

Continued from previous page...

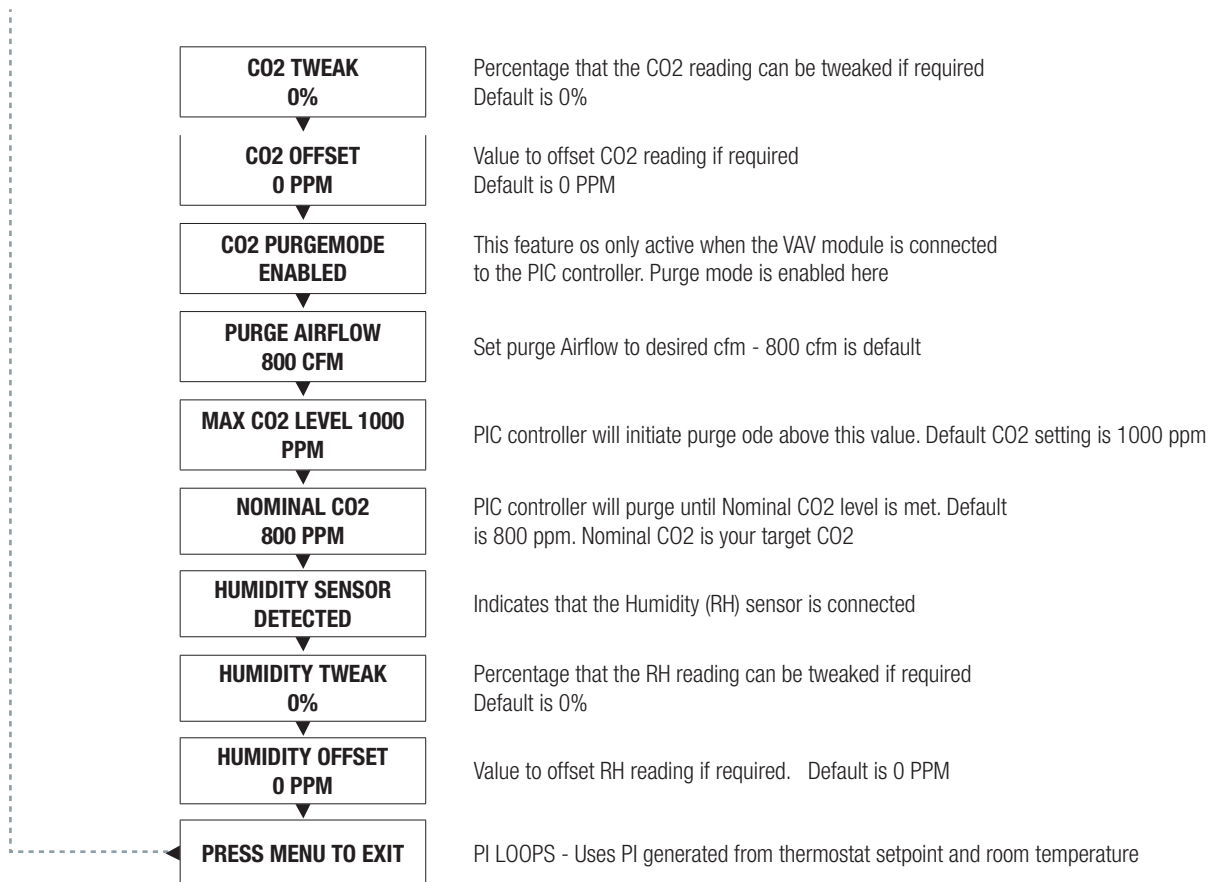

PRICE INTELLIGENT CONTROLLER

DISPLAY NAVIGATION

Output Menu - FAN

(Setup of Fan Outputs)

Scroll through menu with Up and Down keys. Press 'Enter/Menu' button to apply your changes. *---Saving---* will display as your changes are applied.

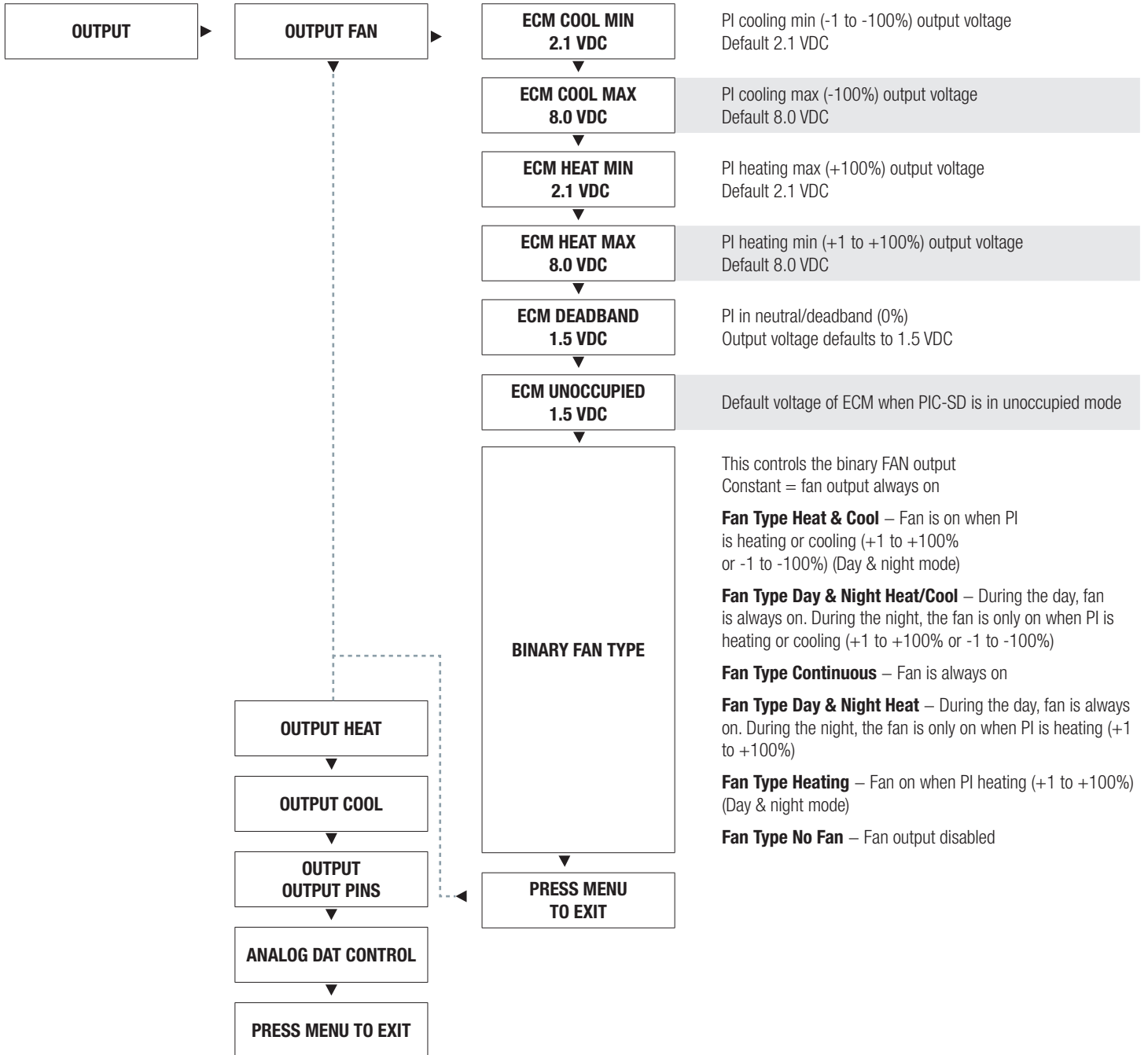

PRICE INTELLIGENT CONTROLLER

DISPLAY NAVIGATION

Output Menu - Heat

(Setup of Heat Outputs)

Scroll through menu with Up and Down keys. Press 'Enter/Menu' button to apply your changes. *---Saving---* will display as your changes are applied.

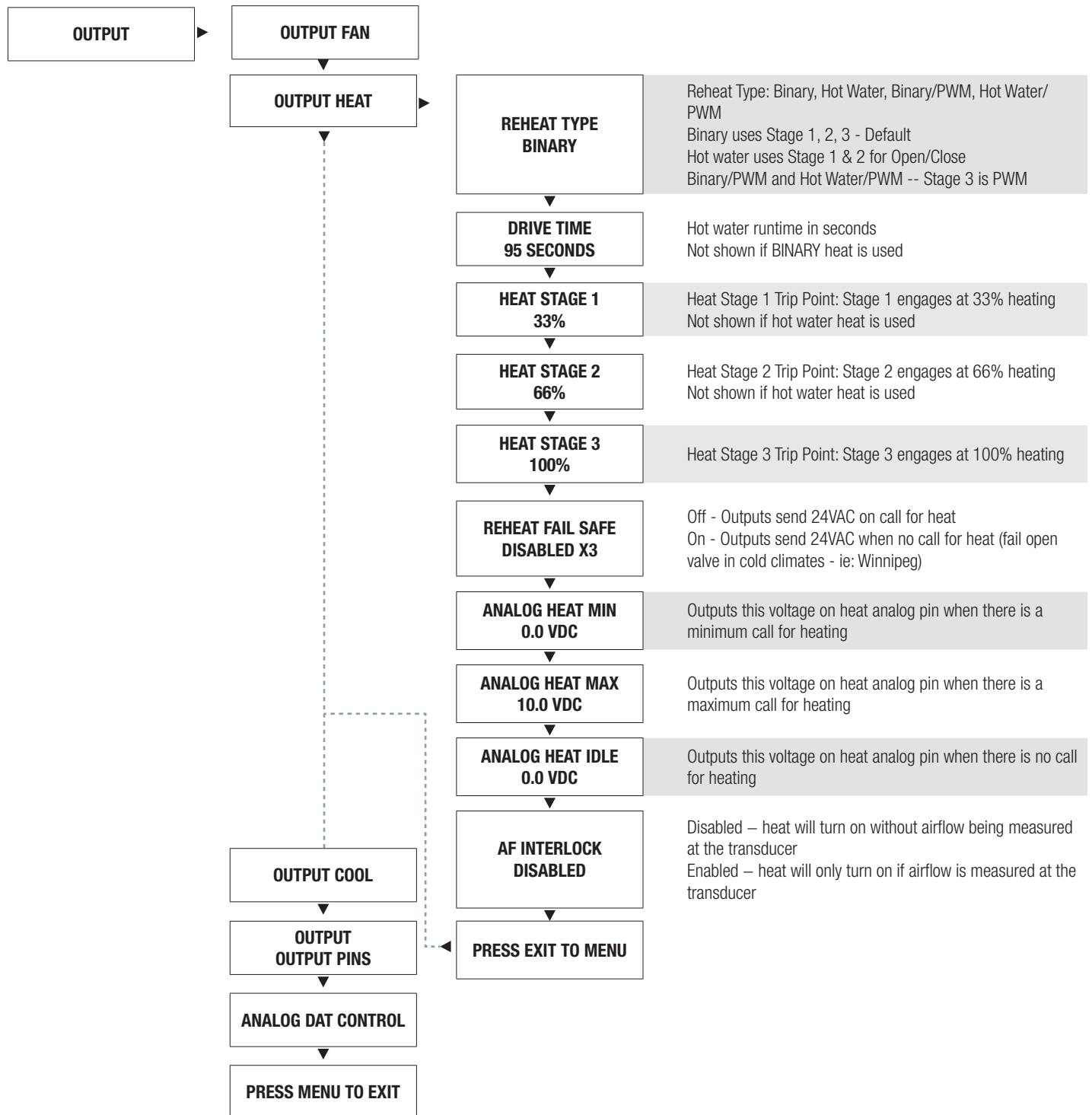

PRICE INTELLIGENT CONTROLLER

DISPLAY NAVIGATION

Output Menu - Cool

(Setup of Fan Outputs)

Scroll through menu with Up and Down keys. Press 'Enter/Menu' button to apply your changes. *---Saving---* will display as your changes are applied.

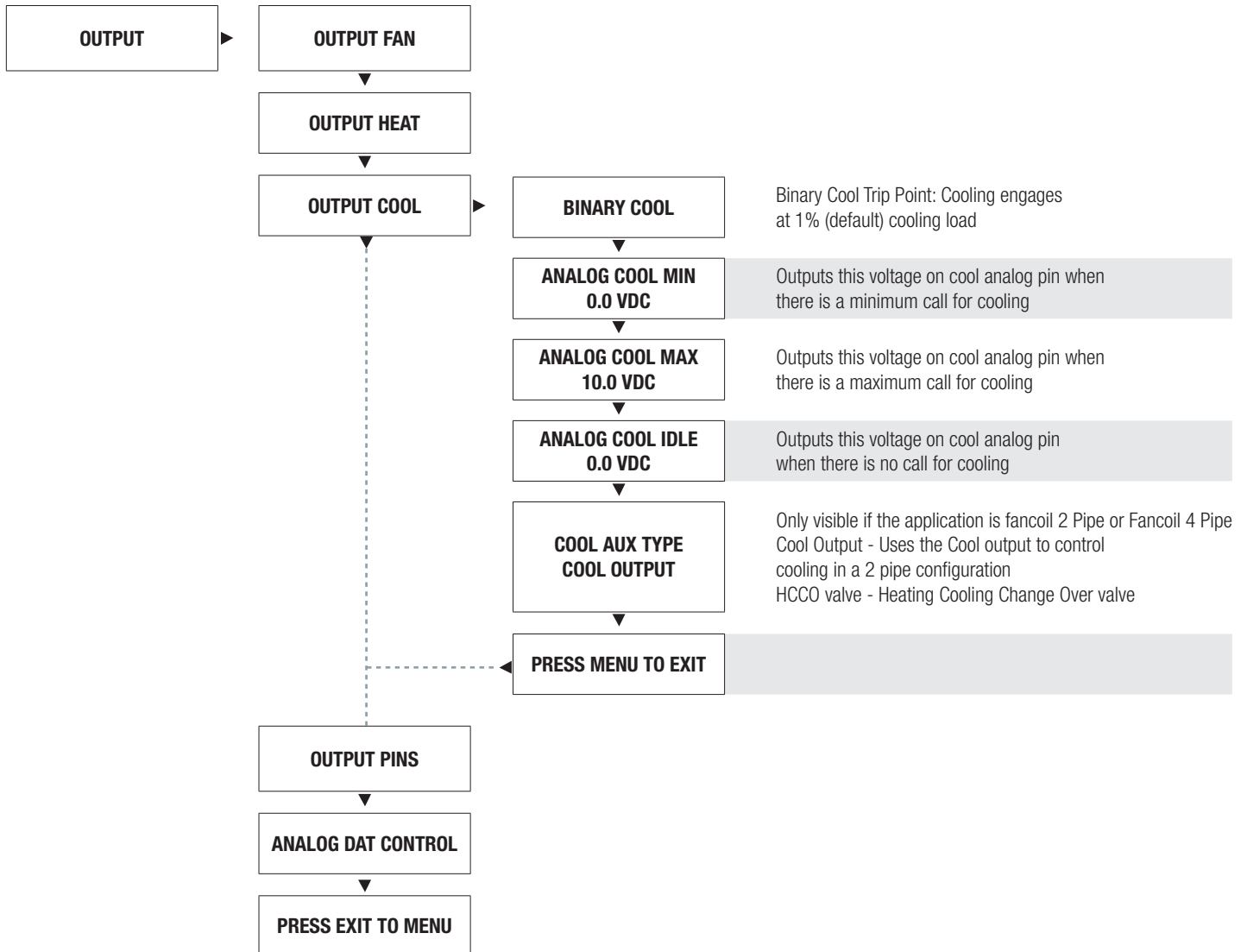

PRICE INTELLIGENT CONTROLLER

DISPLAY NAVIGATION

Output Menu - PINS

Scroll through menu with Up and Down keys. Press 'Enter/Menu' button to apply your changes. *---Saving---* will display as your changes are applied.

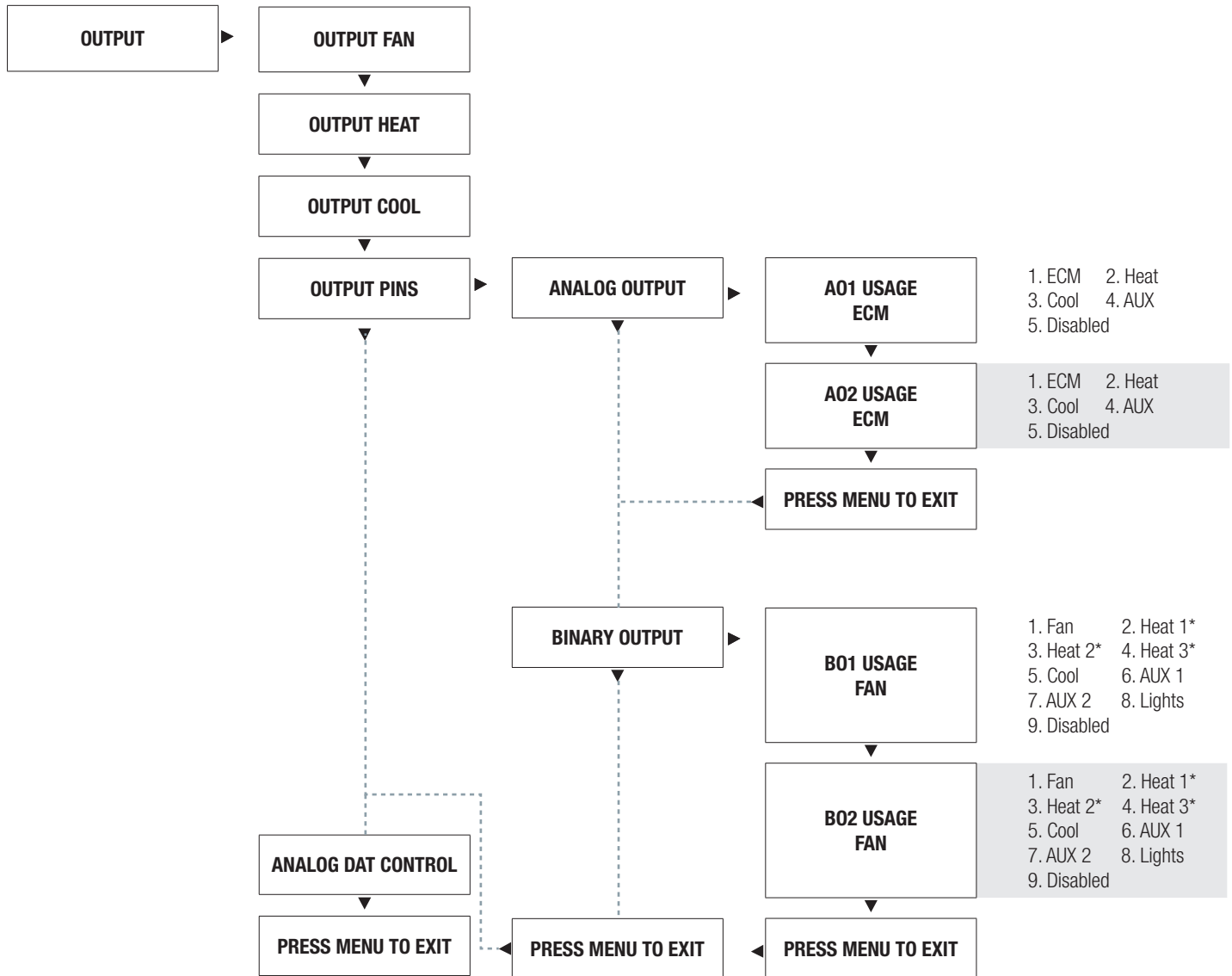

NOTE: Heat 1, Heat 2, Heat 3 only indicate where in the heating proportional band the heat turns on. **There are only 2 Binary Outputs which can be assigned.**
Heat 1 - 1%, Heat 2 - 33%, Heat 3 - 66%

PRICE INTELLIGENT CONTROLLER

DISPLAY NAVIGATION

Output Menu - DAT control

Scroll through menu with Up and Down keys. Press 'Enter/Menu' button to apply your changes. *---Saving---* will display as your changes are applied.

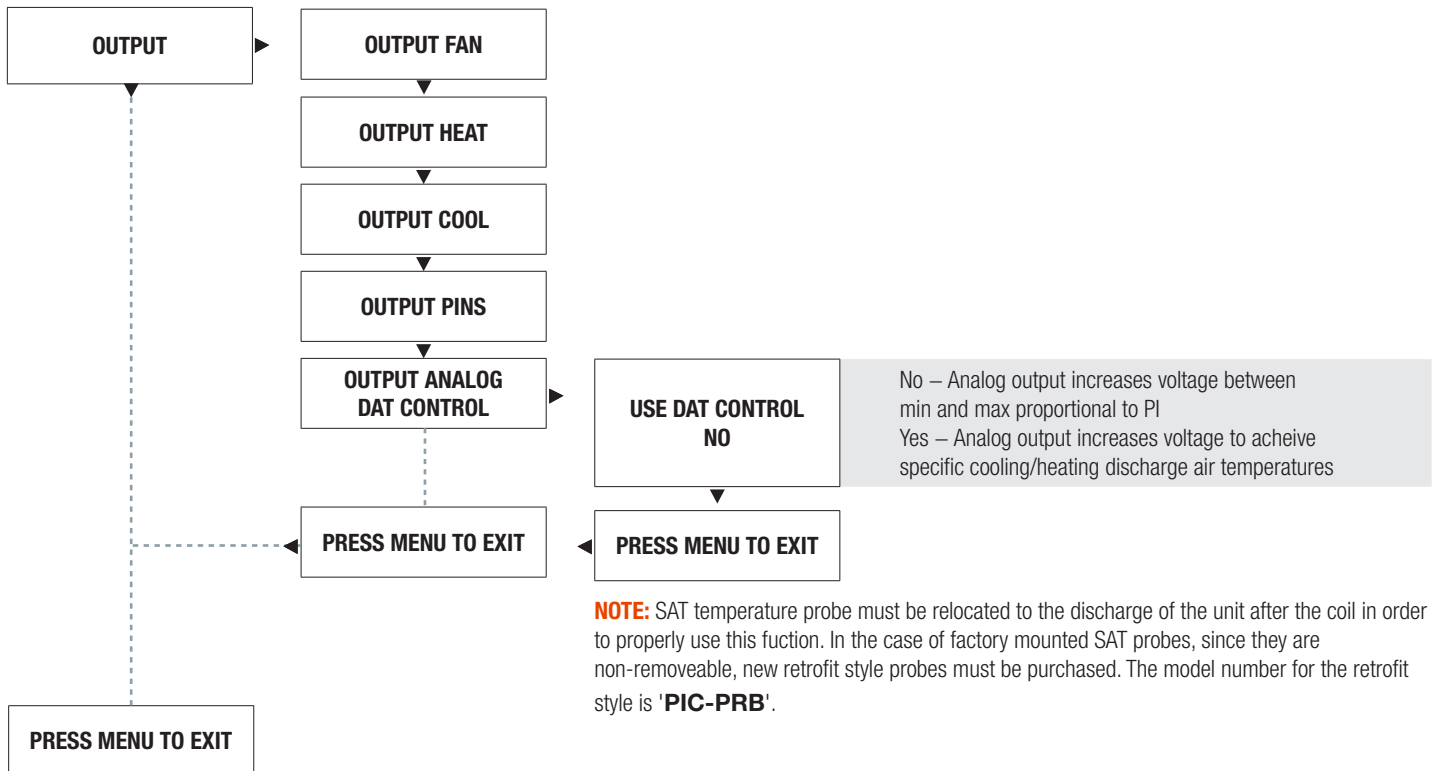

PRICE INTELLIGENT CONTROLLER

DISPLAY NAVIGATION

BACnet Menu

(BACnet Addressing Setup)



Scroll through with the 'Up' and 'Down' buttons. Press 'Enter Menu' button to apply your changes. 'Saving...' will display as your changes are applied.

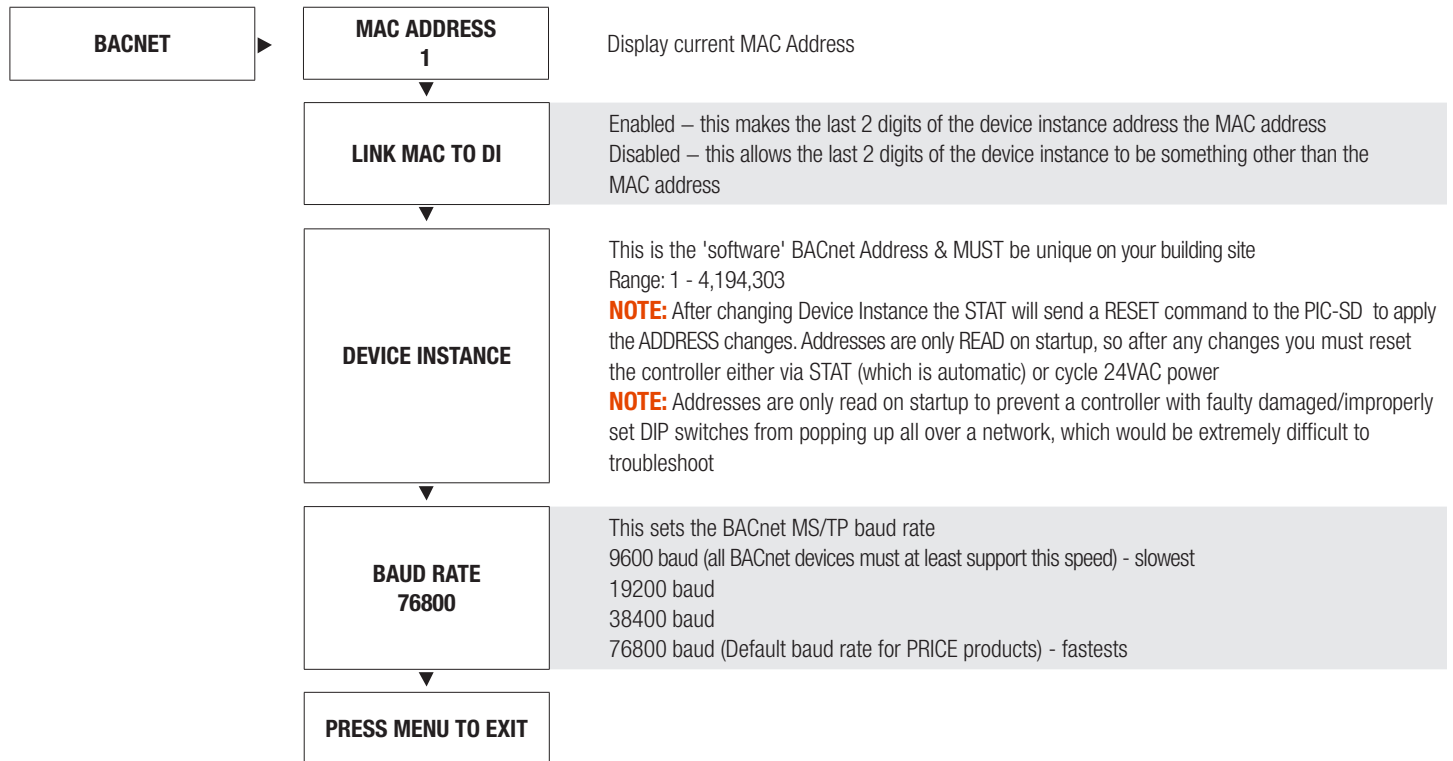

PRICE INTELLIGENT CONTROLLER

DISPLAY NAVIGATION

Stat Setup Menu

(Stat Options)



Scroll through with the 'Up' and 'Down' buttons. Press 'Enter Menu' button to apply your changes. 'Saving...' will display as your changes are applied.

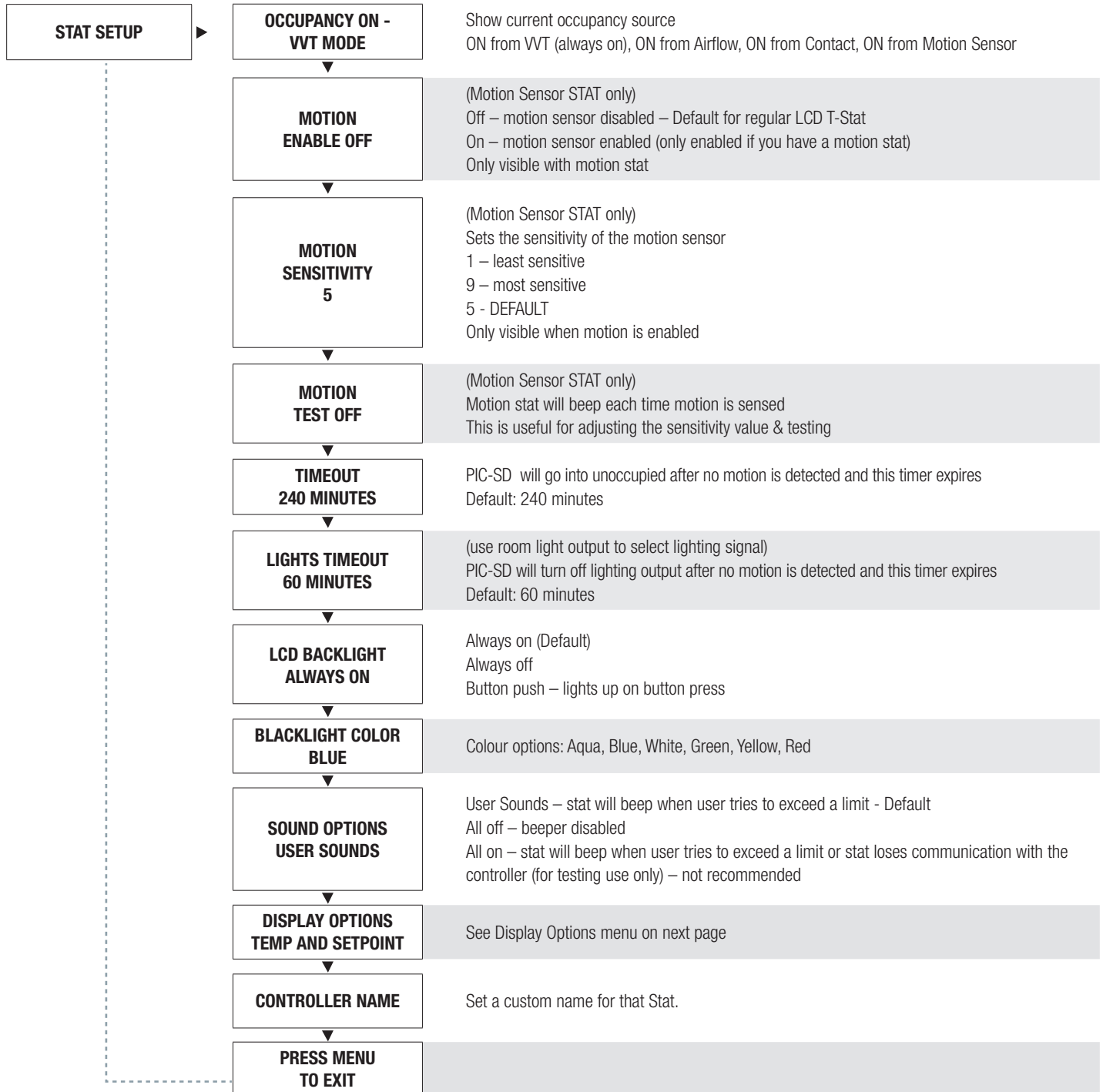

PRICE INTELLIGENT CONTROLLER

DISPLAY NAVIGATION

Display Options Menu

Scroll through menu with Up and Down keys. Press 'Enter/Menu' button to apply your changes.

---Saving--- will display as your changes are applied.

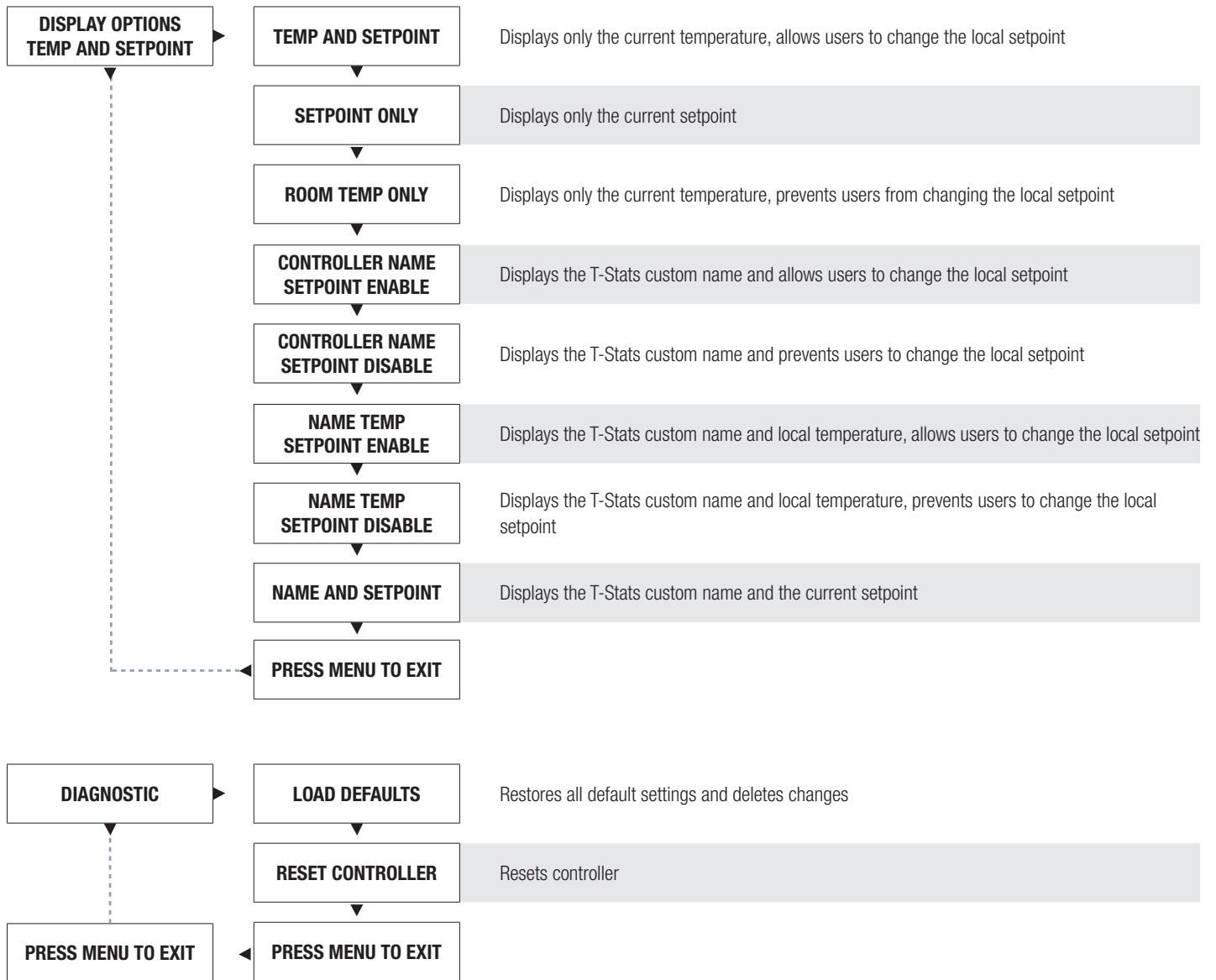

PRICE INTELLIGENT CONTROLLER

BACNET NETWORKING

Network Wire Specifications

For the BACnet MS/TP network specific wire is required. Do not use standard power or “thermostat” wire. This wire does not have the necessary requirements for digital communications. While it’s possible it may work (temporarily) the network will be unreliable and not operating at optimal.

BACnet MS/TP Wire type recommendations

- Use 1 balanced twisted pair
- Low capacitance (17pF or less)
- Plenum rated (FT6, CMP ratings)
- 100-120 ohm, Balanced
- (CAT5, CAT5E, CAT6 network cable has excellent specifications and will work in almost any BACnet MS/TP application.)
- **Price recommends using the Orange Compliment for (+), the Orange for (-), and the Brown and Brown Compliment for the (NET COM) connections. These are paired in a standard CAT5E cable.**

NOTE: NETCOM MUST BE WIRED









Termination

BACnet MS/TP networks must be terminated to ensure proper operation. A network should be terminated twice, once at the beginning and once at the end. Termination helps reduce reflections and noise. The terminating can be done with a 100 ohm resistor across the + and - lines.

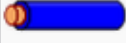
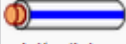
Tech Tip: The Price BACnet MS/TP to IP Router has built in termination and it is enabled by default (since the router is typically the beginning of the entire MS/TP network). Now you only have to go and find/terminate that last device.

WIRING ▼

	T568B Color
PIN 1	 white/orange stripe
PIN 2	 orange solid
PIN 3	 white/green stripe
PIN 4	 blue solid
PIN 5	 white/blue stripe
PIN 6	 green solid
PIN 7	 white/brown stripe
PIN 8	 brown solid

Electrical Noise

Electrical noise can affect both analog signal and digital communications such as BACnet. Therefore do not route high voltage lines next to the BACnet network! Avoid noisy electrical sources such as:

- Variable Frequency Drives
- High current power lines (main panel feeds)
- Fluorescent light fixtures

If you must pass near noisy electrical lines cross at right angles. This will help reduce the amount of noise coupled to the network wires.

ELECTRICAL NOISE EXAMPLE ▼

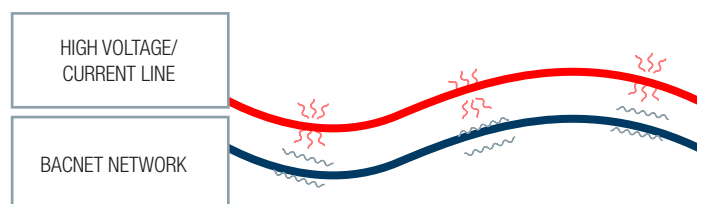

PRICE INTELLIGENT CONTROLLER

BACNET NETWORKING

BACnet Networking and Setup

Setting the MAC Address:

MAC (media access control) must be UNIQUE on an MS/TP network segment within building. An installer setting up an MS/TP segment with 30 devices must ensure each device has a UNIQUE MAC Address (Range 1-99). The MAC Address is set through the LCD thermostat.

NETWORK SEGMENT #1 ▼

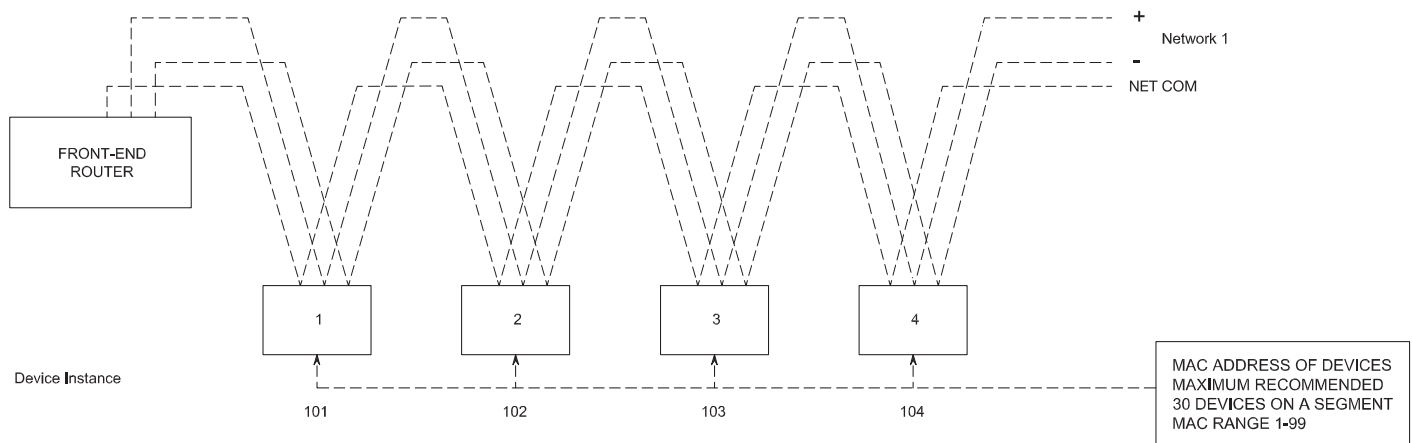

NETWORK SEGMENT #2 ▼

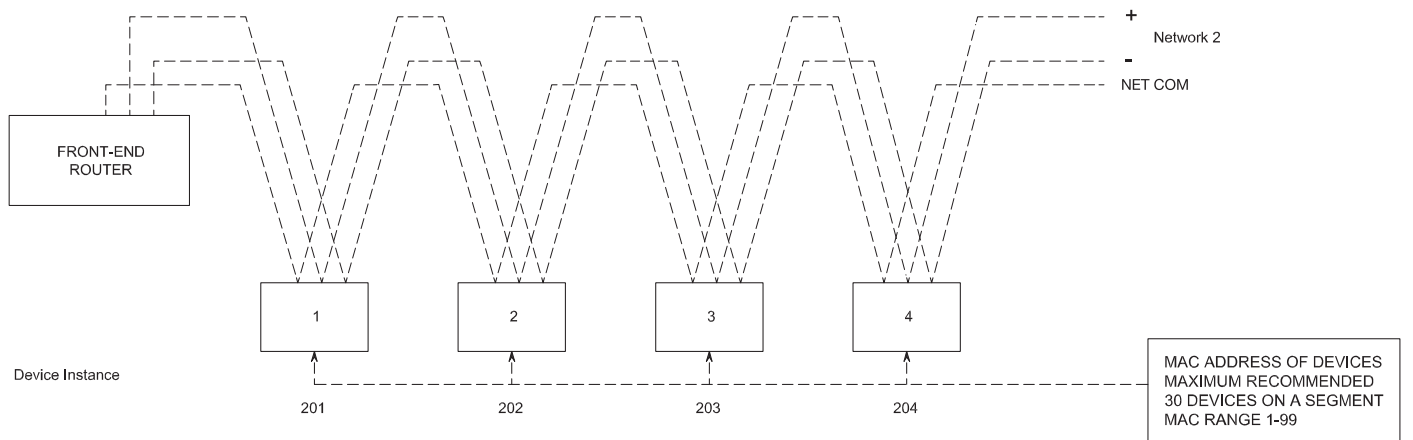

TECH TIP ▼

Each device needs a unique MAC and Device Instance. All devices must be at the same baud rate. 24 VAC HOT and COMMON polarities are critical and must not be reversed on ANY devices! Reverse polarity will stop communication on that MS/TP segment.

NET COM wire must be connected at each device and is critical for BACnet network reliability.

Use one twisted pair for + and -, and another twisted pair for NET COM for optimal noise cancellation.

PRICE INTELLIGENT CONTROLLER

BACNET NETWORKING

Setting the Device Instance (Coupled MAC and DI)

Device Instance:

A Device Instance number identifies a device within an entire building, therefore giving it a unique number or Address, much like a telephone ext. number. A building can have one telephone number, but all the extensions have a unique number to identify them. A Device Instance number would work the same way and must be unique throughout the building. The Device Instance number is user set through the LCD Thermostat or the LCD-SETUP tool.

Below is a table defining how a Device Instance number is obtained.

NOTE: Each device on a network segment must be set to run at the same speed or baud rate.

Description	Default Value (Factory)	Notes
MAC Address	6	Value: limited to 1-99
Tier1 (x100)	58	Value: limited to 0-99
Tier2 (x10,000)	1	Value: limited to 0-99
Tier3 (x1,000,000)	0	Value: limited to 0-4

Example Device Instance setup with Default settings:

- MAC Address = 6 (6 x 1 = 6) – Set through software
- +
TIER 1 = 58 (58 x 100 = 5800) – Set through software
- +
TIER 2 = 1 (1 x 10,000 = 10,000) – Set through software
- +
TIER 3 = 0 (0 x 1,000,000 = 1,000,000) – Set through software

=
Final Device Instance = 0,015,806

<input type="text" value="0"/>	<input type="text" value="01"/>	<input type="text" value="58"/>	<input type="text" value="06"/>
Tier3	Tier2	Tier1	MAC
Multiplier	Multiplier	Multiplier	Address

LCD-SETUP ▼



TECH TIP ▼

When using a PIC-SD controller with a DIAL thermostat, you must purchase a setup tool in AIO known as a LCD-SETUP and use this to configure the PIC-SD controller. Remember all settings are stored in the PIC-SD Controller and not the thermostat.

PRICE INTELLIGENT CONTROLLER

BACNET NETWORKING

Setting the Device Instance (De-coupled MAC and DI)

Device Instance:

A Device Instance number identifies a device within an entire building, therefore giving it a unique number or Address, much like a telephone ext. number. A building can have one telephone number, but all the extensions have a unique number to identify them. A Device Instance number would work the same way and must be unique throughout the building. The Device Instance number is user set through the LCD Thermostat or LCD-SETUP tool.

Below is a table defining how a Device Instance number is obtained.

NOTE: Each device on a network segment must be set to run at the same speed or baud rate.

Description	Example Value	Notes
Tier 1 (x01)	4	Value: limited to 1-99
Tier 2 (x100)	58	Value: limited to 0-99
Tier 3 (x10,000)	1	Value: limited to 0-99
Tier 4 (x1,000,000)	0	Value: limited to 0-4

Example Device Instance setup with table settings from above:

- TIER 1 = 4 (4 x 1 = 4) – Set through software

+

TIER 2 = 58 (58 x 100 = 5800) – Set through software

+

TIER 3 = 1 (1 x 10,000 = 10,000) – Set through software

+

TIER 4 = 0 (0 x 1,000,000 = 1,000,000) – Set through software

=

Final Device Instance = 0,015,804

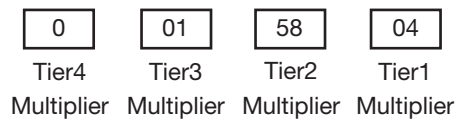

PRICE INTELLIGENT CONTROLLER

BACNET NETWORKING

BACnet Service Menu

Each controller's MAC address, Device Instance, and Baud rate are set in the BACnet sub-menu of the service menu accessed through an LCD thermostat or LCD setup tool. For information on how to select a MAC address and Device Instance for any controller on a network, see the following pages.

To set the controller's BACnet settings, enter the **Service Menu** and adjust settings as follows:

NOTE: When the screen displays a flashing value, that value is ready to be changed and can be adjusted by pressing the arrow keys. Pressing **Menu** will save the value.



Hold down the **Menu** button on the LCD Thermostat for **5 seconds** until prompted for a passcode; use **▲** and **▼** to enter the passcode; **DOWN, UP, UP, DOWN**.

The screen will now display "Service Menu: Application."

Scroll down to the BACnet sub-menu.

Press the **Menu** button to enter this menu.

Screen will now show "MAC Address." Press **Menu**, and now "1" will begin flashing; this means you can now scroll **UP** or **DOWN** with the arrow keys to select a new MAC address. Once you arrive at your desired number, press **Menu** to save.

By default, the MAC address will appear as the last 2 digits of the device instance. This can be changed so that the MAC is completely independent of the device instance by changing 'Enabled' to 'Disabled'. If there is no specific need to do this, Price recommends leaving it enabled (for Price PRTUs systems and most other scenarios, there is no need to switch to disabled).

The device instance defaults to 100, but will be displayed with the last 2 digits as the MAC if the previous screen was set to enabled. Press **Menu** then use the arrow keys to change the device instance.

NOTE: Each Menu press will allow changes in different tiers of the device instance (so that you don't have to scroll for extended periods to get into the millions range - supposing that's where you need to set your device instance).

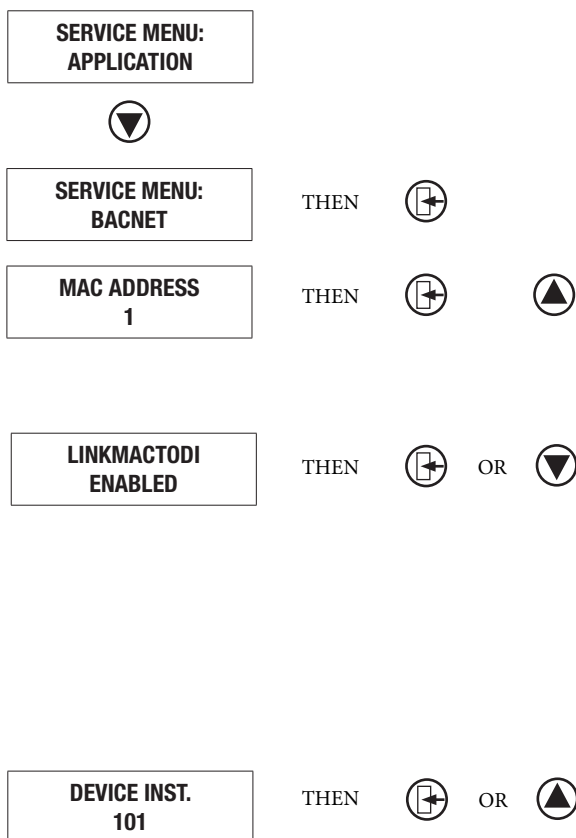

PRICE INTELLIGENT CONTROLLER

BACNET NETWORKING

BACnet Service Menu Continued

Each controller's MAC address, Device Instance, and Baud rate are set in the BACnet sub-menu of the service menu accessed through an LCD thermostat or LCD setup tool. For information on how to select a MAC address and Device Instance for any controller on a network, see the following pages.

To set the controller's BACnet settings, enter the **Service Menu** and adjust settings as follows:

NOTE: When the screen displays a flashing value, that value is ready to be changed and can be adjusted by pressing the arrow keys. Pressing **Menu** will save the value.



THEN



OR



The baud rate is the speed that the MS/TP network runs at. EVERY device on the network must run at the same speed. Price controllers are defaulted to a baud rate of 73800, but can be changed to 38400, 19200, or 9600. For a network segment with all Price controllers (including Price PRTU systems), it's recommended that the baud rate be left at 76800.

*Choose lower baud rates only when integrating with devices by other manufacturers whose maximum speed is lower than 76800 (eg. 38400).

Once all settings are made, scroll down to press **Menu** to exit, and press **Menu**. The controller will then re-start, this is because all BACnet info is only read once at startup. If you had left the MAC set in hardware, and adjusted the DIP switch settings to set the MAC address, you would have to manually restart the controller by cycling 24 VAC power for the new MAC address to take effect (setting through software makes the restart happen automatically however).

PRICE INTELLIGENT CONTROLLER

MAINTENANCE

Troubleshooting

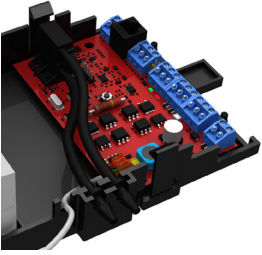
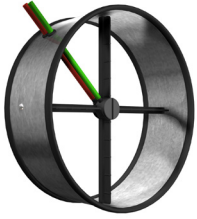

The following information is provided in the event that the PIC-SD does not appear to function properly after installation.

Fault	Solution
<p>PIC-SD controller appears to be not responding or have no power. White status LED is not blinking</p>	<p>Check thermostat first for either green indication light, or LCD display. If either of these does not appear, then check the PIC-SD controller for power (green blinking light). If no power is present, check 24VAC power with a Multimeter. Cycle power to the controller. If this doesn't restore power, check the power that is feeding that controller for your problem</p>
<p>Damper acts erratically</p> 	<p>Check actuator mounting; ensure that the damper is fully closed when the actuator is in the fully closed position. Pivot the black release clutch on actuator and move by hand. Ensure that the set screw on the damper shaft is torqued down tight and no slipping is occurring.</p> <p>Also, ensure the 3 wires in the actuator itself are wired correctly. Green to COM, black to CW, and red to CCW.</p>
<p>Airflow readings not as specified</p>  <p>PRICE SP300 FLOW SENSOR</p>	<p>Ensure that the tubing is correct. Red tube from the Price SP300 sensor to the HI Port on the transducer, and the Green tube from the SP300 to the Lo Port on the transducer. Also, ensure that the tubes are fully over the barbed fitting on the sensor, and that the tubes are not pinched in any way.</p> <p>Check inlet size of duct and ensure that size is correctly set in the controller.</p> <p>NOTE: The STAT does not store the duct size, it is stored in the PIC-SD.</p>
<p>24VAC Binary Outputs not functioning</p>	<p>Ensure that the PIC-SD has 24VAC power.</p> <p>Ensure that there is a call for heating or for cooling, if so, check to see that the indication lights is on for the output.</p> <p>The next step would be to check the device that is triggered the output like a relay. Ensure that the relay has engaged (pulled in) for either heating or cooling application.</p> <p>The next item to check for would be the Hot/COM jumper on the PIC-SD. Make sure that if you're switching the Hot side, that the jumper is on the Hot, likewise for switching a common, ensure the jumper is on the COM.</p>

PRICE INTELLIGENT CONTROLLER

MAINTENANCE

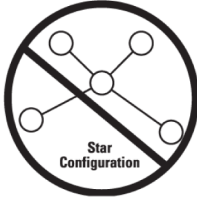
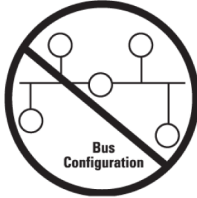
Troubleshooting - Continued





Fault	Solution
Analog Outputs not functioning	<p>Ensure that the PIC-SD has 24VAC power. Check the analog output for voltage with a multimeter. You should see a voltage in the range of 0-10VDC.</p> <p>Direct Acting Output - 0VDC indicates that the field device is closed or in the minimum position. 10VDC indicates that the field device is open or in the maximum position. Direct acting is typical with cooling applications.</p> <p>Reverse Acting Output – 0VDC indicates that the field device is fully opened or maximum position, and 10VDC indicates fully closed or minimum position. Reverse acting is typical with heating applications.</p>
SAT Sensor Analog Input not functioning	<p>Ensure that there is a sensor wired to the input on the PIC-SD controller. Check the type of sensor, should be a 10k Ohm Type Thermistor.</p>
BACnet Communication Errors 	<p>BACnet</p> <p>MS/TP is based on a RS-485 network. It must be wired in a daisy chain configuration. A daisy chain means that there is only one main cable, and every network device is connected directly along its path.</p> <div style="display: flex; justify-content: space-around; align-items: center;">    </div> <p>DO NOT use Star, Bus, "T", or any other type of network configuration. Any of these other network configurations will result in an unreliable network, and make troubleshooting almost impossible.</p> <p>Correct polarity is imperative on MSTP wiring. Always ensure that the positive terminal on a device has the same color wire connected to it throughout the network, same for the negative terminal. Eg. 2 wire conductor with black and white wires – black to the positive terminal, and white to the negative terminal. Keep this consistency throughout the network.</p>

PRICE INTELLIGENT CONTROLLER

MAINTENANCE

Troubleshooting - Continued

The following information is provided in the event that the Price Intelligent Controller (PIC-SD) does not appear to function properly after installation.

Fault	Solution
BACnet Communication Errors 	BACnet MS/TP networks must be terminated to ensure proper operation. A network should be terminated twice, once at the beginning and once at the end. Termination helps reduce reflections and noise. The terminating can be done with a 100 ohm resistor across the A+ and B- lines. The network speed or baud rate must be the same throughout the network. NOTE: The default speed for Price BACnet MS/TP controls is 76800. BACnet MS/TP currently supports 4 standard speeds which are: 9600, 19200, 38400 and 76800.
BACnet Communication Errors 	Binary Address must be unique for each device on the network. No two devices can have the same Address. This includes if you are incorporating a Price product into an existing network. Determine the existing binary Addressing scheme for the existing network. The Address is set on the PIC-SD.
BACnet Communication Errors 	Grounding and 24VAC polarity: Proper grounding is absolutely essential when wiring the MS/TP BACnet Network. Proper grounding will prevent many potential problems that can occur in a network of devices. Common symptoms of a poorly grounded network can include inconsistent BACnet MS/TP communications and damage from voltage spikes. The most practical method of grounding is to ground every 24VAC transformer common/neutral used to power the controls. Connect the “common/neutral” wire of the SECONDARY side of the transformer to earth ground – such as the ground screw on in the electrical box.
BACnet Communication Errors 	NOTE: Flipping 24VAC HOT and COMMON will cause the BACnet MS/TP Network to stop communicating!!! Ensure HOT and COMMON are not reversed on ANY controllers. WARNING: Controllers will still power up and run even if HOT and COMMON are reversed. However output signals to other devices such as heaters, relays, etc will not work as intended!

PRICE INTELLIGENT CONTROLLER

MAINTENANCE

Hardware Specifications

Power Requirements	24VAC, 47-63 Hz 6VA (not including output loading) NEC Class II Use only Limited Power Source LPS rated 100VA Max
Ambient Ratings	32° to 131° F (0° to 55° C) 10 to 90% RH (non-condensing)
Outputs	Two 24VAC Binary Outputs. Max 0.5 Amps each, MAX 1.85A total Switched HOT or Switched COMMON <ul style="list-style-type: none">• Fan• Stages of heat or heat open/close (x2)• Cooling Analog 0-10VDC. Max: 10mA each <ul style="list-style-type: none">• Fan (ECM)• Heat• Cool• Aux
Inputs	Thermistor Sensor (10K Type J thermistor) Analog 0-10V inputs (x2). 20k ohm input impedance <ul style="list-style-type: none">• Thermostat Inputs• Room Setpoint Dial• Configurable Contact Closure• Temperature Sensor (10K Type J Thermistor)• Accuracy of +/- 0.5°F from 55°F to 85°F (+/- 0.25°C from 13°C to 25°C)
Communication ports	BACnet MS/TP Connection <ul style="list-style-type: none">• Communication speeds: 9,600, 19,200, 38,400, 76,800 (default)• Maximum recommended devices per MS/TP segment: 30 devices• For local setup using Price USB LINKER service tool
Size	11" x 5.75" x 2.75"
Weight	1.8lb. (816g)

This document contains the most current product information as of this printing.
For the most up-to-date product information, please go to priceindustries.com

© 2021 Price Industries Limited. All rights reserved.

PRICE[®]